

URYU

POWER TOOLS GENERAL CATALOG







FEEL PHOENIX

BATTERY OIL-PULSE TOOLS

UBX-AF series UBX-AF500Z / AF600Z / AF700Z / AF900Z

UBX-T series UBX-T40D / T50 / T50D / T60 / T60D / T70 / T80

ELECTRIC OIL-PULSE TOOLS

UCX-AF series UCX-AF600L / AF600 / AF700 / AF900

PIONEER of PNEUMATIC TOOLS in JAPAN established in 1915

Since established in 1915 as the pioneer manufacturer of pneumatic tools in Japan, we have been maintaining the top leading position in all respects. Now, the name of "URYU" has become remarkably popular worldwide with the customers who love quality. It is our honor to introduce our latest products to you with this catalog for your additional productivity and greater profit.

URYU has acquired ISO14001 and ISO9001 certifications.



CONTENTS

BOLT & NUT SETTERS	5
Features of PHOENIX Pulse Unit (PAT.)	6
SELECTION CHART	8
BATTERY OIL-PULSE TOOLS	
UBX-AF SERIES	11
UBX-T SERIES	13
BP-T SERIES	15
SUPER "INTELEC" SYSTEM SERIES	19
OIL-PULSE TOOLS	
UAT SERIES	32
UL SERIES	34
CORNER TYPE	35
U / UXR SERIES	36
RATCHET WRENCHES	37
OPEN-END / GEARED WRENCHES	38
ANGLE NUTRUNNERS	39
IMPACT WRENCHES	40
SELECTION CHART	41
FASTENING COUNTER WITH POKA-YOKE	46
NUTRUNNERS	48
SCREWDRIVERS	49
SELECTION CHART	51
TORQUE CONTROL	52
CUSHION CLUTCH / DIRECT DRIVE / IMPACT	54
ABRASIVE TOOLS	58
GRINDERS	59
SANDERS / POLISHERS	64
DRILLS & TAPPERS	67
DRILLS	68
TAPPERS	70
PERCUSSION TOOLS	71
RIVETING HAMMERS	72
IMPACT CUTTERS / FLUX CHIPPERS	74
CHIPPING HAMMERS	75
TESTERS & ACCESSORIES	77
TESTERS	78
ACCESSORIES	82
SAFETY MANUAL	83
NOISE & VIBRATION	86
INDEX / URYU NETWORK	96

BOLT & NUT SETTERS

SCREWDRIVERS

ABRASIVE TOOLS

DRILLS & TAPPERS

PERCUSSION TOOLS

TESTERS & ACCESSORIES

NOISE & VIBRATION

Explanation of each item in Specifications

1 Model		2 Capacity (Nominal Bolt Size)		3 Torque Range		4 Free Speed min ⁻¹			5 Overall Length		6 Weight		7 From Center to Outside		8 Sq. Drive or Hex. Size		9 Air Inlet Thread (Pipe Tap)		10 Air Hose Size		11 Average Air Consumption		12 Code	
		mm	in	Nm	ft-lbs	0.4MPa	0.5MPa	0.6MPa	mm	in	kg	lb	mm	in	mm	in	in		mm	in	m ³ /min	ft ³ /min		
13 Max. Torque		14 Hex. size of Ratchet		15 Hex. size of Gear socket		16 Hex. Size of Bit		17 Capacity (Wheel Size)		18 Capacity (Pad/Paper Size)		19 Drilling Capacity												
Nm	ft-lbs	mm	in	mm	in	mm	in	mm	in	mm	in	mm	in											

1 Model

A tool type together with numerals represents the model name. For query or order, please specify this Model.

2 Capacity (Nominal Bolt Size)

For tool selection when a required torque is vague or not clearly specified, choose an appropriate model by referring to capacity. For the optimal torque by equation for each size of bolt, please refer to P. 38. When a required torque is specified, please refer to the next item, Torque Range.

3 Torque Range

It shows the torque for a type of tool measured by a tester and the like. The value is a measured torque in accordance with our measuring standard, which is not always identical to a break-away torque value. For a torque-adjustable model, torques with low & upper-limit are indicated respectively for the specified air pressure.

4 Free Speed

It shows the standard free speed when a tool is run under free-load. Be aware that some difference from the actual measured value may be seen since there is a permissible range with standard for free speed, for each model. For grinder, the maximum free speed is indicated. For the maximum horse power for air motor incorporated in a tool, it is generally obtained at speed around 1/2 of its free speed. For selection of drill, please take note of this point. (Refer to P. 69.)

5 Overall Length

It shows the maximum length from the tip to the end of a tool. A small variation may be seen on an actual tool due to adjustment during the assembly process. Any attachment such as socket, bit, grinding wheel, auger, snap, coupler for air supply is not included. Suspension Ring is not included, either.

6 Weight

It shows the weight of a tool. A small variation may be seen on an actual tool due to adjustment during the assembly process. Any attachment such as socket, bit, grinding wheel, auger, snap, coupler for air supply is not included.

7 From Center to Outside

It shows the distance from the center of rotation spindle (output spindle) to the maximum outside diameter. For pistol-type model, Handle (grip part) nor a projection for Suspension Ring is not included. For straight-type model, Valve Lever is not included.

8 Sq. Drive or Hex. Size

It shows the shape and dimension of an output spindle. For oil-pulse wrench or impact wrench, the anvil is square drive type, and the dimension represents the distance between two surfaces. (ex. 9.5Sq = square with 9.5mm, 25.4Sq = square with 25.4mm) A model name suffixing D is for hex. bit inserting type, and the bit inserting dimension is indicated. (ex. 6.35Hex = bit attaching spindle with 6.35mm)

9 Air Inlet Thread (Pipe Tap)

It shows the nominal air inlet size for a pipe screw. In principle, the tool side has got a female screw.

10 Air Hose Size

It shows the appropriate inside diameter of an air hose for air supply. Please be noted that the provided capacity may not be achieved if any other air hose besides the recommended inside diameter is used.

11 Average Air Consumption

It shows air volume to be consumed by the tool. It indicates the value when the air is returned to free atmosphere pressure. Therefore, the average air consumption is approx. 1/6 of listed value when the supplied air pressure is 0.5MPa.

12 Code

It shows our computer code for each model.

13 Max. Torque

It shows the fastening ability for stall type which stops the motor with maximum load. It may differ from the breakaway torque of bolt fastened by each tool.

14 Hex. size of Ratchet

It shows the available width across flats on each ratchet wrench. Please specify Hex. size when ordering, since the hexagon socket for fastening is incorporated in these models.

15 Hex. size of Gear socket

It shows the available width across flats on each open-end wrench and geared wrench. Please specify Hex. size when ordering, since the hexagon socket for fastening is incorporated in these models.

16 Hex. Size of Bit

It shows the inserting size of bit. Please refer to page 48 for suitable bit of each model.

17 Capacity (Wheel Size)

It shows the available wheel dimensions for straight grinder, angle grinder, and vertical grinder. Please use within prescribed wheel dimension, since the greatest wheel dimension is decided due to safety regulations.

18 Capacity (Pad/Paper Size)

It shows the diameter of suitable pad/paper.

19 Drilling Capacity

It shows the maximum diameter of drill which drill chuck mounted as standard can fix.

BOLT & NUT SETTERS

BATTERY OIL-PULSE TOOLS

SUPER "INTELEC" SYSTEM CONTROLLER

SUPER "INTELEC" SYSTEM ELECTRIC OIL-PULSE TOOLS

SUPER "INTELEC" SYSTEM AMC · MC TOOLS

UAT · ULT · UL SERIES OIL-PULSE TOOLS

U · UXR SERIES OIL-PULSE TOOLS

RATCHET WRENCHES

OPEN-END WRENCHES · GEARED WRENCHES

ANGLE NUTRUNNERS

IMPACT WRENCHES

FASTENING COUNTER WITH POKA-YOKE

NUTRUNNERS

Uryu original technology

Features of PHOENIX Pulse Unit (PAT.)

Overwhelming Performance with powerful PHOENIX!

New design with No springs helps to overcome challenges with conventional pulse tools and ensures the maximum performance of electric tool.

Long Life

Durability improved by 400%!

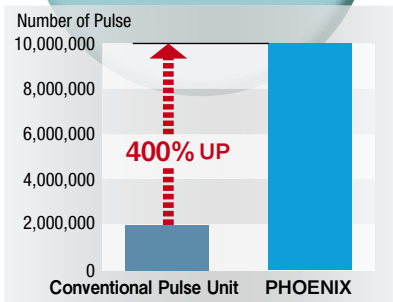

Pulse Counts until Pulse Maintenance increased 400%

High Output

Output increased by 35%!

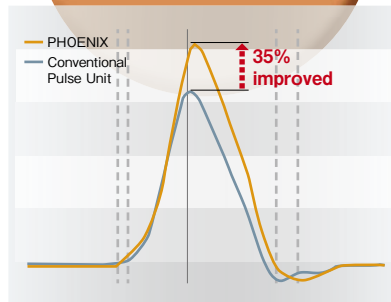

Output Peak Value increased by 35%

High-efficiency

Minimizes temperature increase! No need to warm up before use!

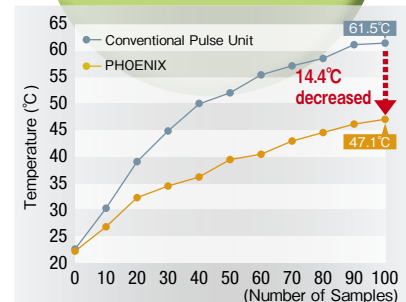

Heat Generation during fastening decreased by 30%

*Comparison with conventional pulse tool. Calculated under URYU test condition. It varies depending on the usage condition.

Newly Developed PHOENIX Pulse Unit (PAT.)

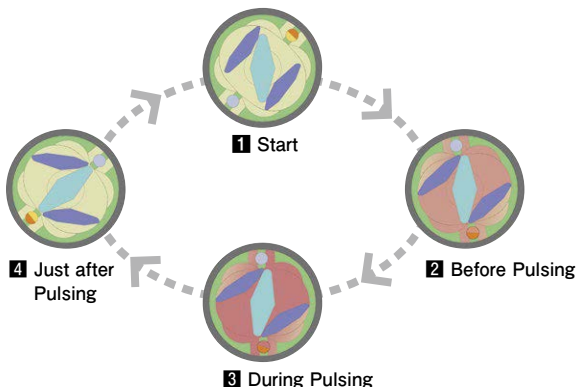
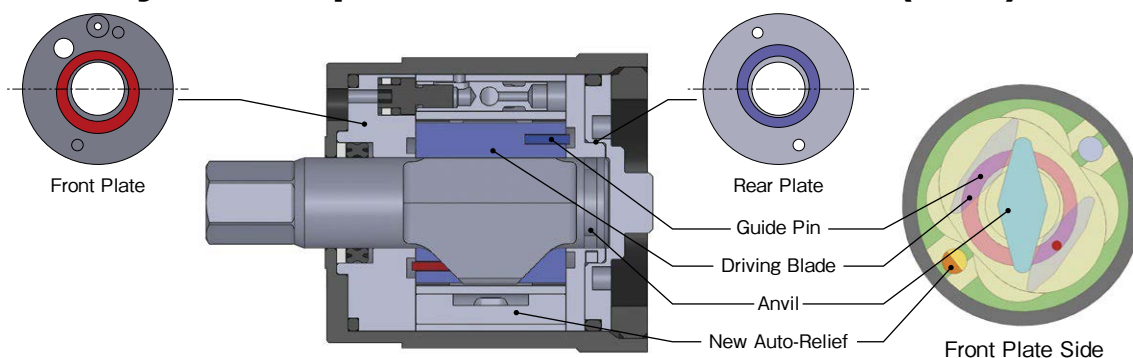

Guide pins provided on one side of each driving blade are connected to the 180° decentered guide (groove) on the rear/front plate and oil inside the pulse unit and guide pins holds the driving blades.

In addition, the driving blade is controlled on a regular track via decentered guide (groove) and guide pin. One impulse per rotation can be made by sealing the pulse unit per rotation.

Features of Newly Developed Auto-Relief (PAT.)

High-quality Fastening Accuracy with Ideal Waveform

Newly developed auto-relief (PAT.) makes the fastening possible with smooth and ideal fastening waveform without being affected by oil degradation.

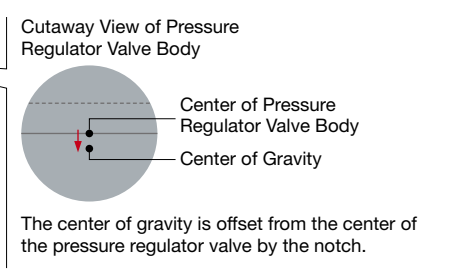
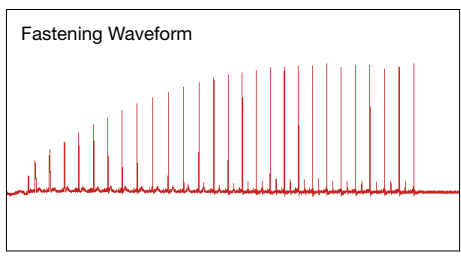
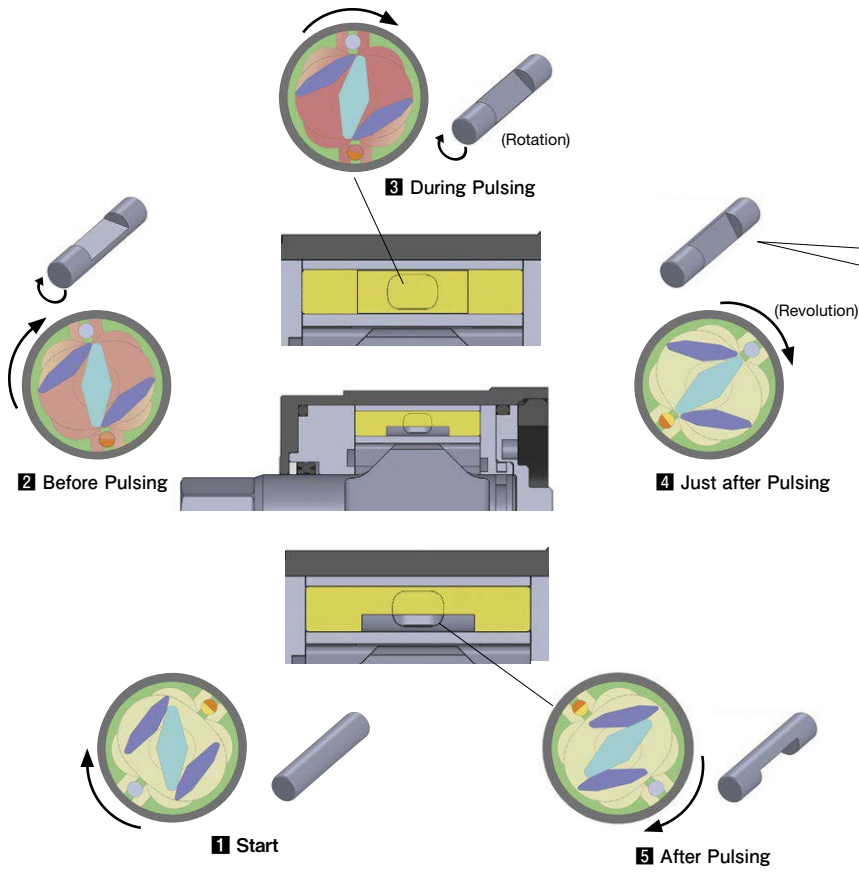

Notches created on the pressure regulator valve body offsets the center of gravity, and the rotational motion of the pulse and the inertial force at blowing activate the auto-relief. The notches on the pressure regulator valve body become bypass for oil, and the bypass is fully opened by centrifugal force due to rotation (revolution) when not pulsing, but the pressure regulator valve body rotates due to inertia when pulsing, and shut off the bypass unit. This new design makes the fastening waveform ideal without torque spike.

Newly Developed Small Torque & Angle Sensor

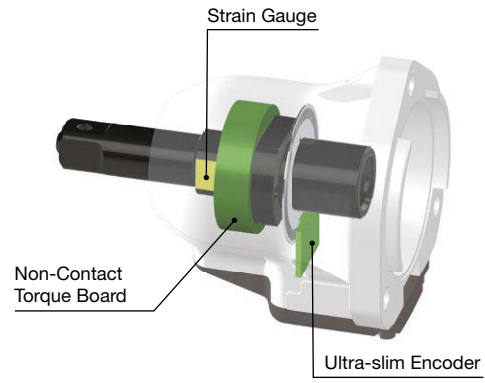

Small and power saving torque and angle sensor are employed for battery-powered tool. Torque measurement employs non-contact gauge type and angle measurement employs ultra-slim encoder. Small, but strong against vibration and noise. Very reliable sensor.

SELECTION CHART

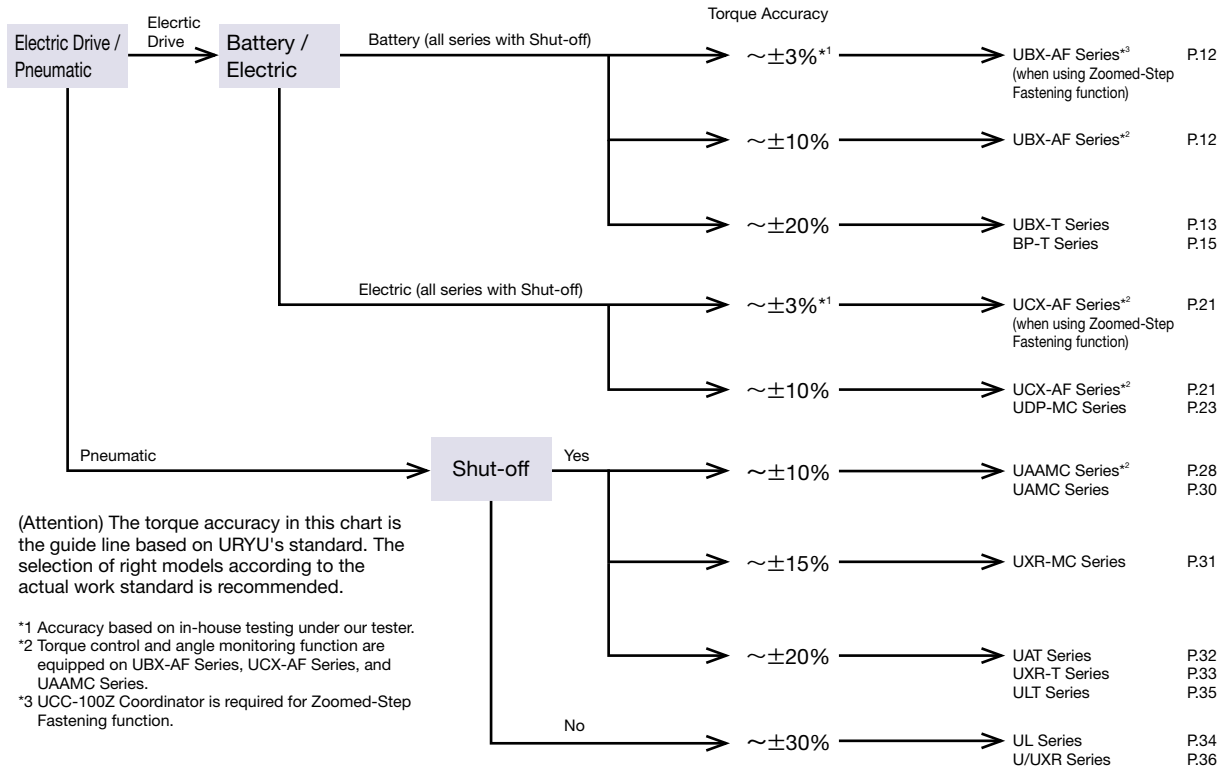

TOOL SELECTION:

Fig. 1 Joint

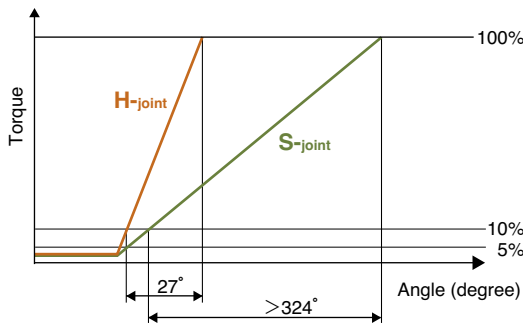

When selecting the tool for fastening operation, it is necessary to consider bolt size, fastening torque, working conditions and so on. Generally, working conditions can be defined as hard joint (H-joint) and soft joint (S-joint) from the aspect of relation between fastening torque and angle. (Please refer to ISO-5393:2017.) It is also necessary to consider characteristics of work pieces.

Fig. 2 Fastening with Oil-Pulse Tool (H-S Joint)

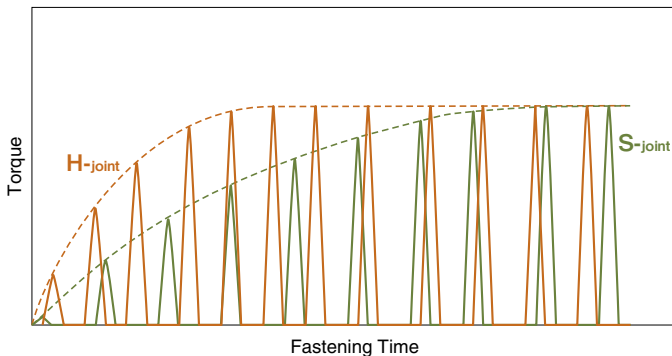

As shown above Fig. 2, torque output curve of the hard joint and soft joint is different when the same torque setting against same tool is applied. (Difference of torque raise up speed and time to reach the target torque.)

Fig. 3 Tool selection by work feature

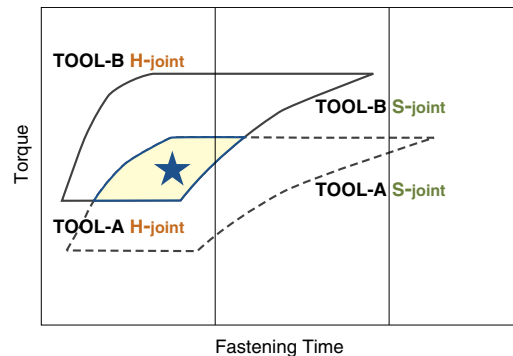

When selecting the tool against the target torque of ★ as shown Fig. 3, pay attention to the operating conditions (tool weight, fastening time), required torque accuracy, torque adjusting position of tools and select the most suitable model.

TORQUE CHART FOR OIL-PULSE WRENCHES

Pistol Type

Straight Type



ELECTRIC TOOL (BATTERY)

●UBX-AF/UBX-T/BP-T series (P.12 - 17)

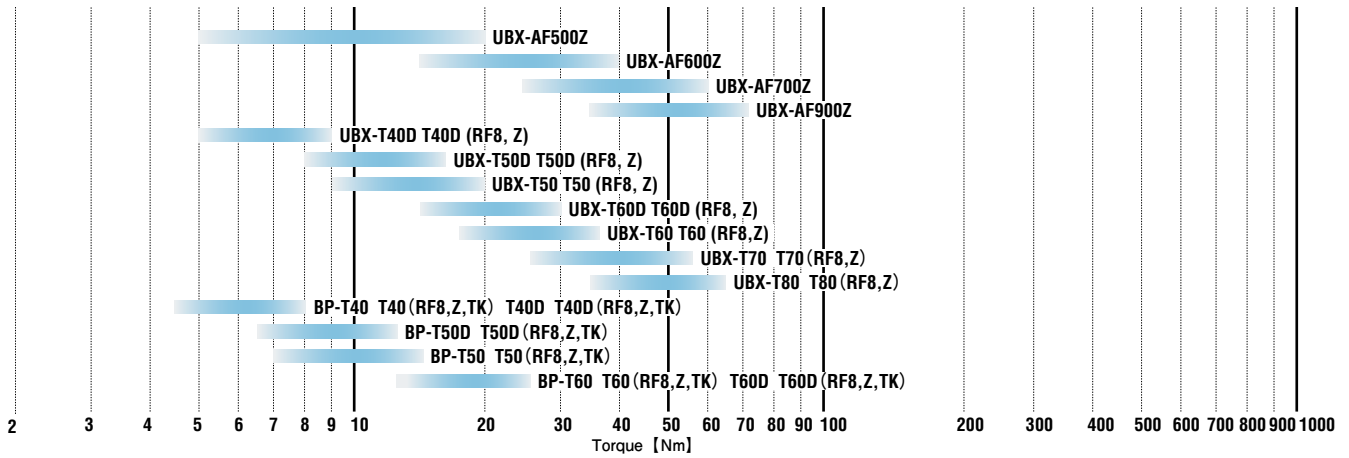

ELECTRIC TOOL (TRANSDUCERIZED TYPE)

●UCX-AF/UDP-MC series (P.21, 23)

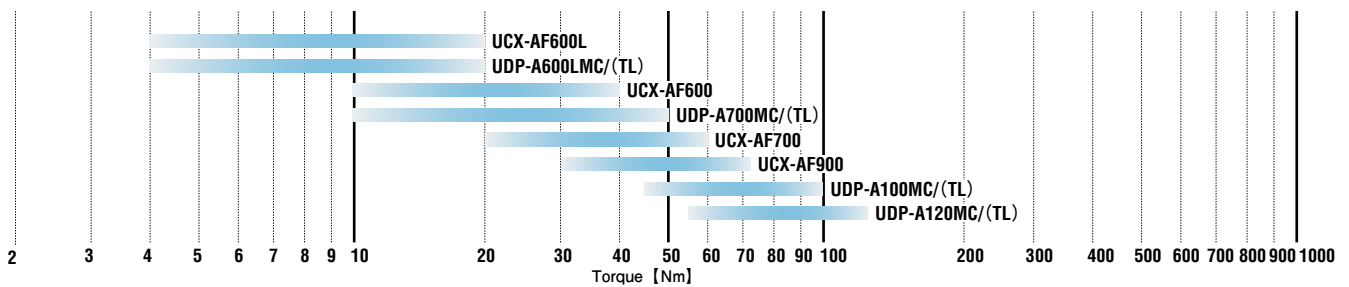

AIR TOOL (TRANSDUCERIZED TYPE)

●UAAMC series (P.28, 29)

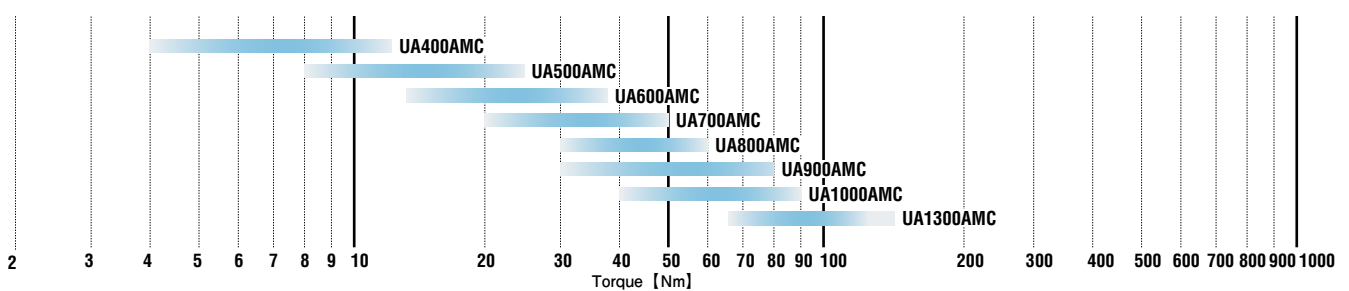

●UAMC series (P.30, 31)

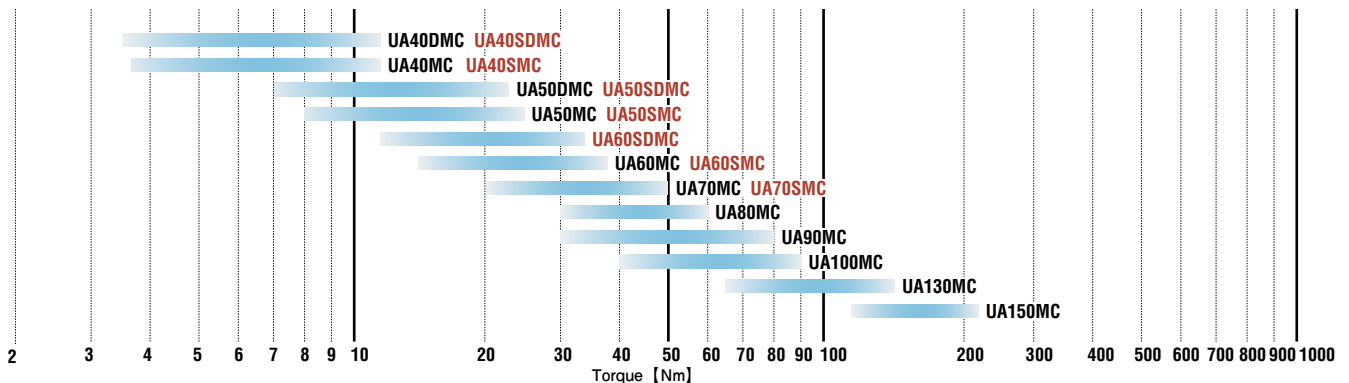

●UXR-MC series (P.31)

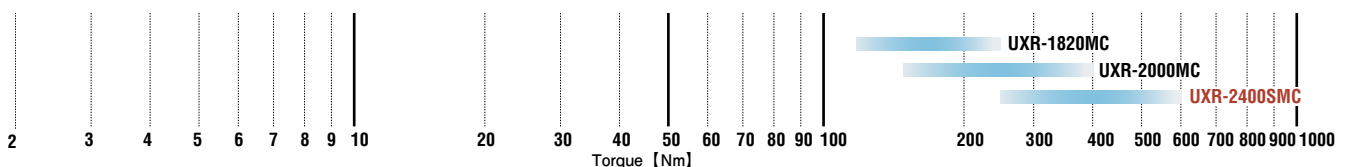

TORQUE CHART FOR OIL-PULSE WRENCHES

Pistol Type

Straight Type

Corner Type



AIR TOOL (SHUT-OFF TYPE)

● UAT series (P.32, 33) ULT series (P.35)

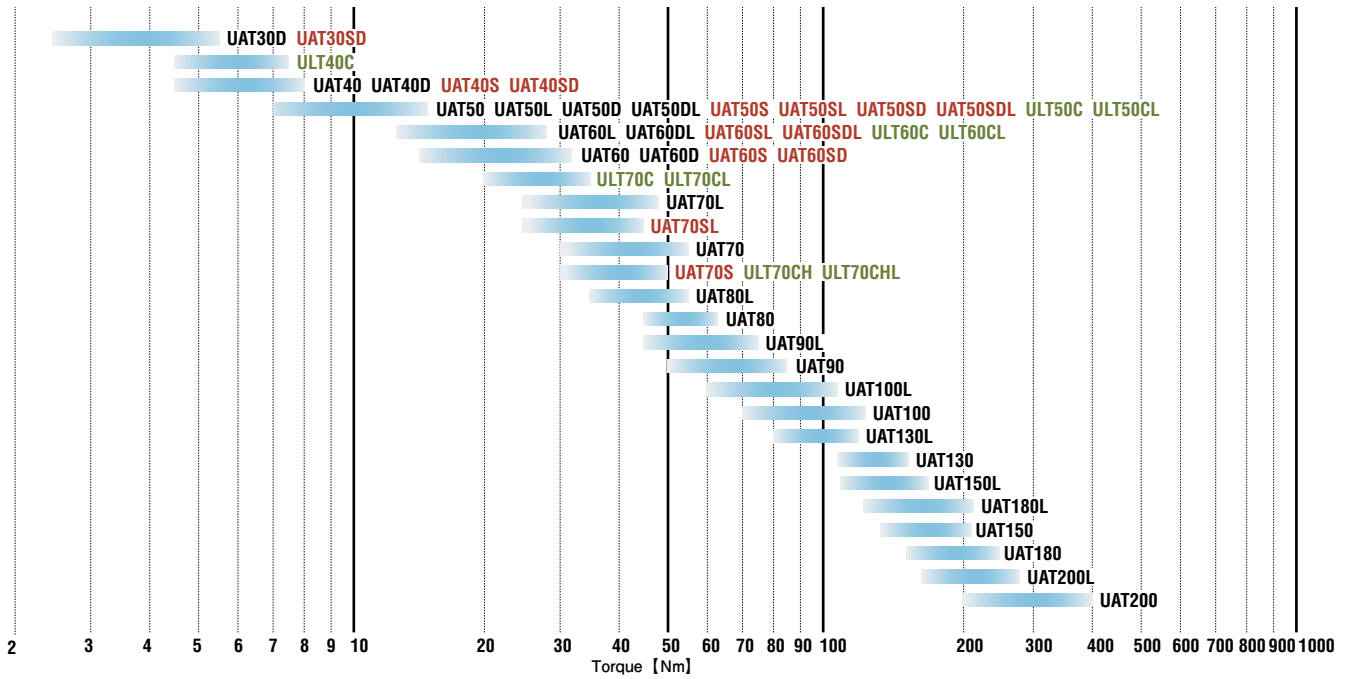

● UXR-T series (P.33)

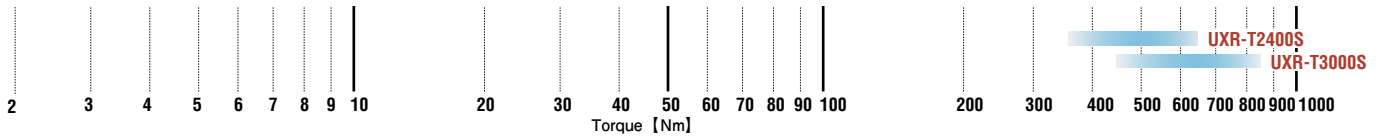

AIR TOOL (NON SHUT-OFF TYPE)

● UL series (P.34)

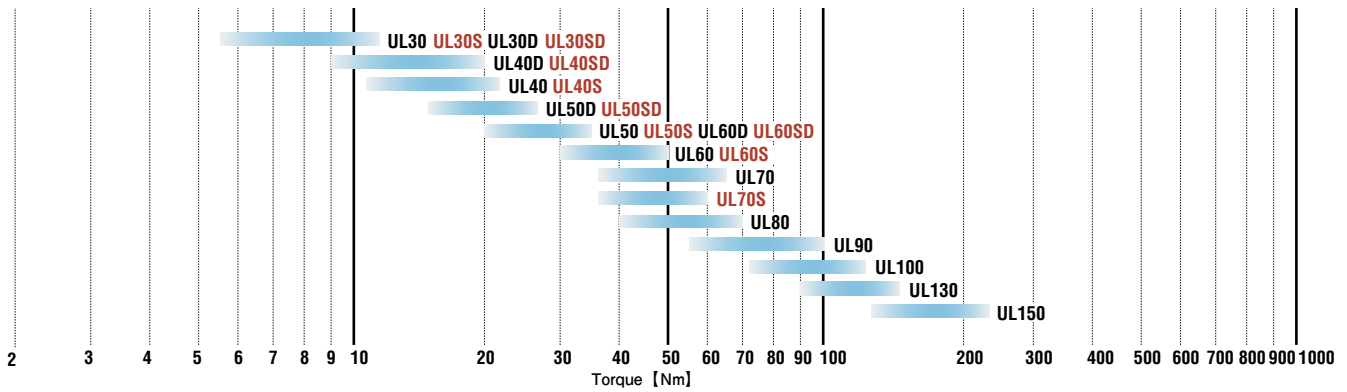

● U / UXR series (P.36)

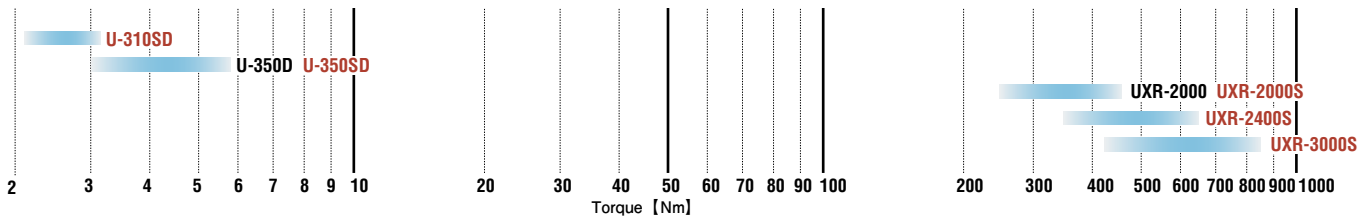

UCC SERIES

UCC-100Z

Multifunctional Coordinator with built-in Wireless unit for UBX-AF Series



UCC SERIES SPECIFICATIONS

MODEL	UCC-100Z
POWER SUPPLY	AC 100-240V ±10%
POWER FREQUENCY	50/60 Hz
INSULATION PROTECTION	DC500V over 10MΩ
POWER CONSUMPTION	35VA
WEIGHT	2.9kg
DIMENSIONS	Without antenna 254(D)×222(W)×99(H) / With antenna 254(D)×233.5(W)×106(H)
MAIN FUNCTIONS	Torque Control / Angle Monitoring / Fastening Counter
PARAMETER SETUP	Manual Input on LCD Panel / Personal Computer (with setup software)
DISPLAY	Torque Resolution ±2048 (12Bit A/D) LCD: 20 Characters×8 lines Contents: TORQUE / WORK NO. / FASTENING COUNT DOWN NO. / FASTENING TIME / PULSE NO. / ANGLE / ERROR MESSAGE
LAMP	COUNT LAMP: OK (Green) / NOK (Red) FASTENING LAMP: LOW (Yellow) / OK (Green) / HIGH (Red)
INPUT TERMINAL SIGNAL	Operation Voltage / Current: DC24V / approx. 10mA, 6 Terminals (free format) Note: Contact input necessary
OUTPUT TERMINAL SIGNAL	Contact Capacity: DC30V, 1A, 6 Terminals (free format)
OPTION	Setting PC Cable (Straight) Part Number: 910-219-0
CODE (A/E)	81Z12/81Z02

UCC-100Z

UBX-AF Series

UCC-100Z Series System Layout

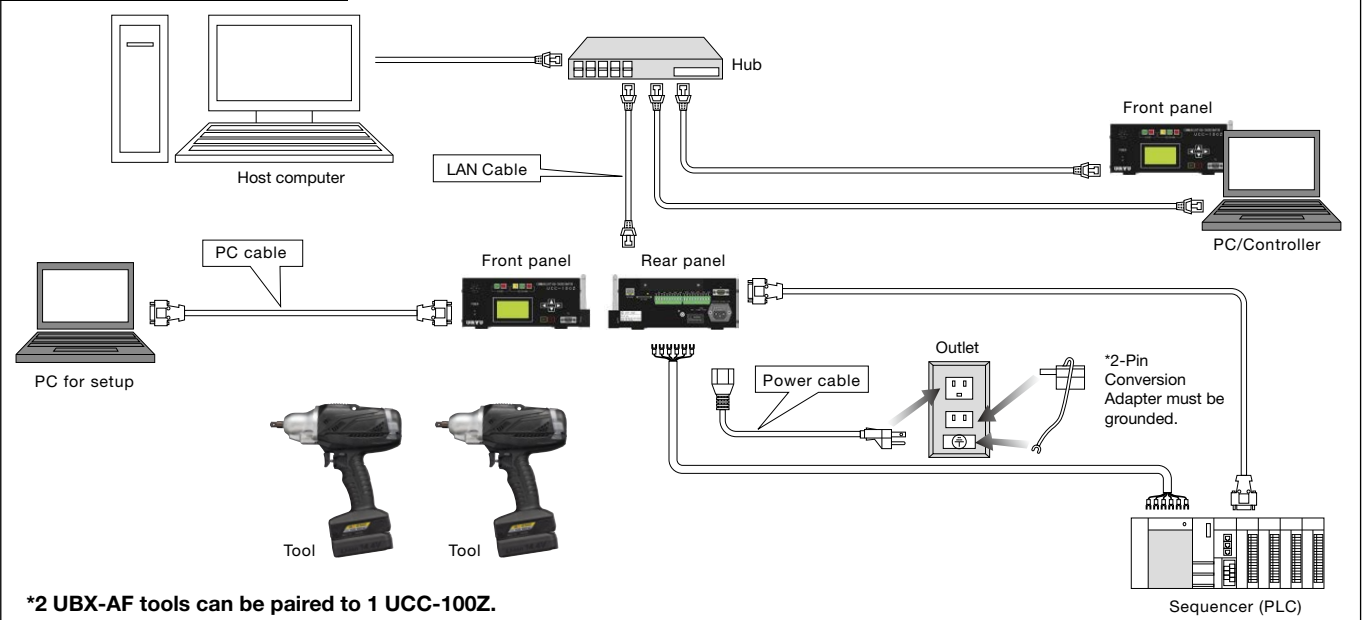

UBX-AF SERIES

Best Performance Battery Tools with Newly Developed PHOENIX pulse, Auto-Relief and Torque & Angle Sensor

BOLT & NUT SETTERS



UBX-AF900Z



UBX-AF500Z



UBX-AF600Z



UBX-AF700Z

* For information on the Radio Law in your country, please contact your nearest URYU distributor.

FEATURE

New design with No springs helps to overcome challenges with conventional pulse tools.

- More powerful
- Minimizes temperature increase
- No need to warm up before use
- Further improved accuracy (approximately twice the conventional tightening) with a newly equipped [Zoomed-Step Fastening] function.
*When using UCC-100Z

Improved Durability

Low oil pressure inside the pulse unit reduces the pressure against sealing, which minimizes oil leakage.

Newly designed Auto-Relief (PAT.) is not affected by oil degradation.

Upsized LED lamp enables operators to judge OK/NOK easily in any posture.

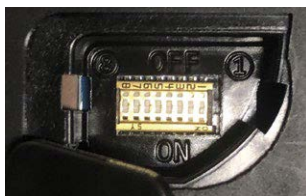

Pairing parameter is selectable from 3 types;

1. Manual Pairing by dip switches
2. Pairing through software
3. Wireless pairing

Fastening parameters are memorized in UCC-100Z coordinator. Quick tool change only by pairing!

Specifications

Model	Capacity (Nominal Bolt Size)		Torque Range		Free Speed (Approx.)	Overall Length less Socket (Approx.)		Weight less Socket				From Center to Outside (Approx.)		Sq. Drive Shank		Battery Voltage (Capacity)	Battery Model (Panasonic)	Number of fastening per minute*	Fastener quantity per full charge	Code
	mm	in	Nm	ft-lbs		mm	in	with battery		with no battery		mm	in	mm	in					
					min ⁻¹			kg	lb	kg	lb									
UBX-AF500Z	6-8	1/4-5/16	5.0-20.0	3.7-14.8	3600	219	8 5/8	1.82	4.01	1.52	3.35	29.5	1 5/32	9.5	3/8	10.8V(2.0Ah)	EYFB32	11	440	12A12
UBX-AF600Z	8-10	5/16-3/8	15.0-40.0	11.1-29.6	4800	219	8 5/8	1.87	4.12	1.52	3.35	29.5	1 5/32	9.5	3/8	14.4V(2.0Ah)	EYFB41	10	320	12A32
UBX-AF700Z	8-12	5/16-1/2	25.0-60.0	18.4-44.4	4800	219	8 5/8	1.91	4.21	1.56	3.44	29.5	1 5/32	9.5	3/8	14.4V(2.0Ah)	EYFB41	9	320	12A52
UBX-AF900Z	10-12	3/8-1/2	35.0-72.0	25.8-53.1	4800	255	10 3/64	2.30	5.07	1.81	3.99	29.5	1 5/32	12.7	1/2	18.0V (3.0Ah)	EZ9L53	6	450	12A72

*Torque Range is a guideline value. Please make tool selection appropriately in accordance with an actual application.

*Battery or Battery Charger is not included. Please use EY0L82 (Panasonic) for Battery Charger.

*Calculated under URYU test condition. It varies depending on the usage condition.

UBX-T SERIES [SHUT-OFF TYPE]

Premium Type Battery Oil-Pulse Tool with PHOENIX Pulse Unit and Auto-Relief



UBX-T60D



UBX-T70



UBX-T80

BOLT & NUT SETTERS

FEATURE

- Compact & Light weight, Low noise, Low vibration, Low reaction & Speedy fastening
- Shut-off reliability improved by diaphragm
- Incomplete Job Error Detection function (TK) is standardized.
- Double-hitting Detection: When a tool shuts off with 2 or less pulses, it is detected as the fastening NOK.

Specifications (Shut-off Type)

Model	Capacity (Nominal Bolt Size)		Torque Range		Free Speed (Approx.)	Overall Length less Socket (Approx.)		Weight less Socket				From Center to Outside (Approx.)		Sq. Drive or Hex. Size		Battery Voltage (Capacity)	Battery Model (Panasonic)	Number of fastening per minute *	Fastener quantity per full charge	Code
	mm	in	Nm	ft-lbs		mm	in	with battery		with no battery		mm	in	mm	in					
					min ⁻¹			kg	lb	kg	lb									
UBX-T40D	5-6	No.10-1/4	5-9	3.7-6.6	3000	183	7 13/64	1.54	3.39	1.25	2.75	27.5	1 3/32	6.35	1/4	10.8V(2.0Ah)	EYFB32	11	800	12C02
UBX-T50D	6-8	1/4-5/16	8-17	5.9-12.5	3900	183	7 13/64	1.54	3.39	1.25	2.75	27.5	1 3/32	6.35	1/4	10.8V(2.0Ah)	EYFB32	10	650	12D02
								1.60	3.52							14.4V(2.0Ah)	EYFB41		330	
UBX-T60D	8-10	5/16-3/8	15-30	11.1-22.1	4800	183	7 13/64	1.83	4.03	1.25	2.75	27.5	1 3/32	6.35	1/4	14.4V(4.0Ah)	EYFB43	8	750	12E02
								1.83	4.03							14.4V(4.2Ah)	EYFB42		790	
UBX-T50	6-8	1/4-5/16	9-20	6.6-14.8	3900	179	7 3/64	1.54	3.39	1.25	2.75	27.5	1 3/32	9.5	3/8	10.8V(2.0Ah)	EYFB32	10	750	12D12
								1.60	3.52							14.4V(2.0Ah)	EYFB41		330	
UBX-T60	8-10	5/16-3/8	18-36	13.3-26.6	4800	179	7 3/64	1.83	4.03	1.25	2.75	27.5	1 3/32	9.5	3/8	14.4V(4.0Ah)	EYFB43	8	750	12E12
								1.83	4.03							14.4V(4.2Ah)	EYFB42		790	
								1.63	3.59							14.4V(2.0Ah)	EYFB41		250	
UBX-T70	8-12	5/16-1/2	25.0-55.0	18.5-40.7	4800	187	7 23/64	1.86	4.10	1.28	2.82	27.5	1 3/32	9.5	3/8	14.4V(4.0Ah)	EYFB43	8	570	12F02
								1.86	4.10							14.4V(4.2Ah)	EYFB42		600	
UBX-T80	10-12	3/8-1/2	35.0-65.0	25.9-48.1	4800	193	7 19/32	1.89	4.16	1.40	3.08	27.5	1 3/32	9.5	3/8	18.0V(3.0Ah)	EY9L53	5	480	12F52

*Torque Range is a guideline value. Please make tool selection appropriately in accordance with an actual application.

*Battery or Battery Charger is not included. Please use EY0L82 (Panasonic) for Battery Charger.

*Calculated under URYU test condition. It varies depending on the usage condition.

OPTION

Optional Tool Jackets

Part Number	Used for	Part Number	Used for	Part Number	Used for
12E-840-1	UBX-T60(D)	12F-840-0	UBX-T70	12F-840-5	UBX-T80

DERIVATIVE MODELS OF UBX-T SERIES [SHUT-OFF TYPE]

Wireless RF8 Type / Z(ZigBee) Type (*)

*For information on the Radio Law in your country, please contact your nearest URYU distributor.

RF8 : Pokayoko configuration

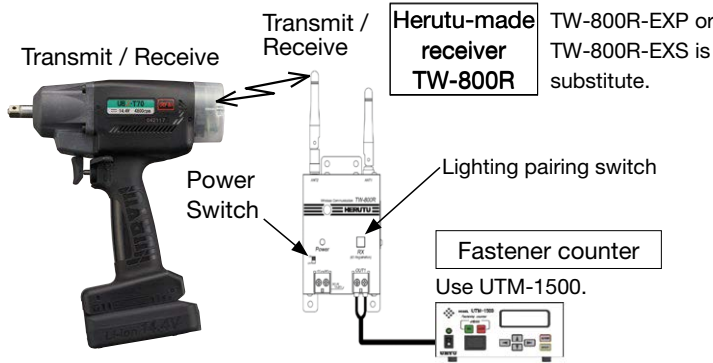

Z(ZigBee) : Pokayoko configuration

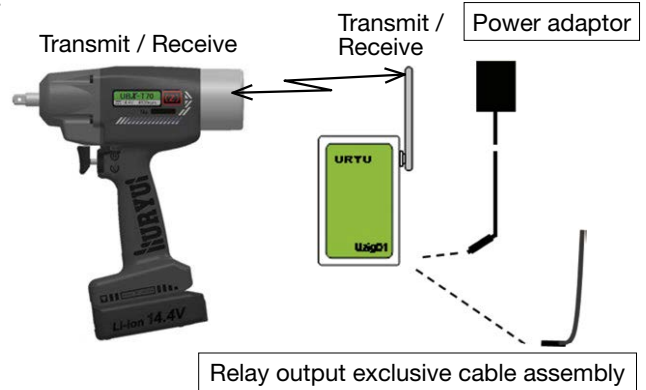

Specifications (Shut-off Type)

Model	Capacity (Nominal Bolt Size)		Torque Range		Free Speed (Approx.)	Overall Length less Socket (Approx.)		Weight less Socket				From Center to Outside (Approx.)		Sq. Drive or Hex. Size		Battery Voltage (Capacity)	Battery Model (Panasonic)	Number of fastening per minute*	Fastener quantity per full charge	Code
	mm	in	Nm	ft-lbs		mm	in	with battery		with no battery		mm	in	mm	in					
	min-1	kg	lb	kg	lb	mm	in	mm	in											
UBX-T40D(RF8)	5-6	No.10-1/4	5-9	3.7-6.6	3000	189	7 7/16	1.54	3.39	1.25	2.75	27.5	1 3/32	6.35	1/4	10.8V(2.0Ah)	EYFB32	11	800	12C42
UBX-T50D(RF8)	6-8	1/4-5/16	8-17	5.9-12.5	3900	189	7 7/16	1.54	3.39	1.25	2.75	27.5	1 3/32	6.35	1/4	10.8V(2.0Ah)	EYFB32	10	650	12D42
UBX-T60D(RF8)	8-10	5/16-3/8	15-30	11.1-22.1	4800	189	7 7/16	1.60	3.52	1.25	2.75	27.5	1 3/32	6.35	1/4	14.4V(2.0Ah)	EYFB41	8	750	12E42
								1.83	4.03							14.4V(4.0Ah)	EYFB43			
								1.83	4.03							14.4V(4.2Ah)	EYFB42			
UBX-T50(RF8)	6-8	1/4-5/16	9-20	6.6-14.8	3900	185	7 9/32	1.54	3.39	1.25	2.75	27.5	1 3/32	9.5	3/8	10.8V(2.0Ah)	EYFB32	10	750	12D52
UBX-T60(RF8)	8-10	5/16-3/8	18-36	13.3-26.6	4800	185	7 9/32	1.60	3.52	1.25	2.75	27.5	1 3/32	9.5	3/8	14.4V(2.0Ah)	EYFB41	8	750	12E52
								1.83	4.03							14.4V(4.0Ah)	EYFB43			
								1.83	4.03							14.4V(4.2Ah)	EYFB42			
UBX-T70(RF8)	8-12	5/16-1/2	25.0-55.0	18.5-40.7	4800	193	7 19/32	1.86	4.10	1.28	2.82	27.5	1 3/32	9.5	3/8	14.4V(2.0Ah)	EYFB41	8	570	12F22
								1.86	4.10	14.4V(4.0Ah)	EYFB43									
								1.86	4.10	14.4V(4.2Ah)	EYFB42									
UBX-T80(RF8)	10-12	3/8-1/2	35.0-65.0	25.9-48.1	4800	199	7 53/64	1.89	4.16	1.40	3.08	27.5	1 3/32	9.5	3/8	18.0V(3.0Ah)	EY9L53	5	480	12F72
UBX-T40D(Z)	5-6	No.10-1/4	5-9	3.7-6.6	3000	200	7 7/8	1.54	3.39	1.25	2.75	27.5	1 3/32	6.35	1/4	10.8V(2.0Ah)	EYFB32	11	800	12C62
UBX-T50D(Z)	6-8	1/4-5/16	8-17	5.9-12.5	3900	200	7 7/8	1.54	3.39	1.25	2.75	27.5	1 3/32	6.35	1/4	10.8V(2.0Ah)	EYFB32	10	650	12D62
UBX-T60D(Z)	8-10	5/16-3/8	15-30	11.1-22.1	4800	200	7 7/8	1.60	3.52	1.25	2.75	27.5	1 3/32	6.35	1/4	14.4V(2.0Ah)	EYFB41	8	750	12E62
								1.83	4.03							14.4V(4.0Ah)	EYFB43			
								1.83	4.03							14.4V(4.2Ah)	EYFB42			
UBX-T50(Z)	6-8	1/4-5/16	9-20	6.6-14.8	3900	196	7 23/32	1.54	3.39	1.25	2.75	27.5	1 3/32	9.5	3/8	10.8V(2.0Ah)	EYFB32	10	750	12D72
UBX-T60(Z)	8-10	5/16-3/8	18-36	13.3-26.6	4800	196	7 23/32	1.60	3.52	1.25	2.75	27.5	1 3/32	9.5	3/8	14.4V(2.0Ah)	EYFB41	8	750	12E72
								1.83	4.03							14.4V(4.0Ah)	EYFB43			
								1.83	4.03							14.4V(4.2Ah)	EYFB42			
UBX-T70(Z)	8-12	5/16-1/2	25.0-55.0	18.5-40.7	4800	204	8 1/32	1.86	4.10	1.28	2.82	27.5	1 3/32	9.5	3/8	14.4V(2.0Ah)	EYFB41	8	570	12F32
								1.86	4.10	14.4V(4.0Ah)	EYFB43									
								1.86	4.10	14.4V(4.2Ah)	EYFB42									
UBX-T80(Z)	10-12	3/8-1/2	35.0-65.0	25.9-48.1	4800	210	8 17/64	1.89	4.16	1.40	3.08	27.5	1 3/32	9.5	3/8	18.0V(3.0Ah)	EY9L53	5	480	12F82

*Torque Range is a guideline value. Please make tool selection appropriately in accordance with an actual application.

*Battery or Battery Charger is not included. Please use EY0L82 (Panasonic) for Battery Charger.

*Calculated under URYU test condition. It varies depending on the usage condition.

OPTION

Optional Tool Jackets

Part Number	Used for
12E-840-3	UBX-T60(D)(RF8)

Part Number	Used for
12F-840-1	UBX-T70(RF8)

Part Number	Used for
12F-840-6	UBX-T80(RF8)

BP-T SERIES [SHUT-OFF TYPE]

Evolving Battery Oil Pulse Tool BP-T series



BP-T40D



BP-T50D



BP-T60D



BP-T60

BOLT & NUT SETTERS

FEATURES

- New grip style in terms of operator's comfort. It protects operator from fatigue.
- Independent cooling fan reduces heat of pulse unit contributing to comfortable operation.
- Compact & High-capacity Li-ion battery provides more fasteners per charge.

Quick-change driver anvil type

On pulling the sleeve, insert or take off the bit.

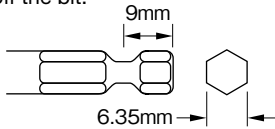

The model name suffixing (D) is the Quick-change driver anvil type.

Specifications (Shut-off Type)

Model	Capacity (Nominal Bolt Size)		Torque Range		Free Speed (Approx.) min ⁻¹	Overall Length less Socket or Bit (Approx.)		Weight less Socket or Bit				From Center to Outside (Approx.)		Sq. Drive or Hex. Size		Battery Voltage (Capacity)	Battery Model (Panasonic)	Number of fastening per minute *	Fastener quantity per full charge	Code
	mm	in	Nm	ft-lbs		mm	in	with battery		with no battery		mm	in	mm	in					
								kg	lb	kg	lb									
BP-T40D	5	No. 10	4.5-8	3.3-5.9	3300	200	7 7/8	1.45	3.19	1.15	2.53	27	1 1/16	6.35	1/4	10.8V (2.0Ah)	EYFB32	11	1000	10A02
BP-T50D	6-8	1/4-5/16	6.5-13	4.8-9.6	3900	200	7 7/8	1.45	3.19	1.15	2.53	27	1 1/16	6.35	1/4	10.8V (2.0Ah)	EYFB32	7	700	10C02
BP-T60D	8	5/16	13-26	9.6-19.2	4800	205	8 5/64	1.60	3.52	1.25	2.75	27	1 1/16	6.35	1/4	14.4V (2.0Ah)	EYFB41	7	600	10E02
BP-T40	5	No. 10	4.5-8	3.3-5.9	3300	197	7 4/3	1.45	3.19	1.15	2.53	27	1 1/16	9.5	3/8	10.8V (2.0Ah)	EYFB32	11	1000	10A12
BP-T50	6-8	1/4-5/16	7-15	5.1-11.1	3900	197	7 4/3	1.45	3.19	1.15	2.53	27	1 1/16	9.5	3/8	10.8V (2.0Ah)	EYFB32	7	700	10C12
BP-T60	8	5/16	13-26	9.6-19.2	4800	202	7 61/64	1.60	3.52	1.25	2.75	27	1 1/16	9.5	3/8	14.4V (2.0Ah)	EYFB41	7	600	10E12

*Torque Range is a guideline value. Please make tool selection appropriately in accordance with an actual application.

*Battery or Battery Charger is not included. Please use EY0L82 (Panasonic) for Battery Charger.

*Calculated under URYU test condition. It varies depending on the usage condition.

OPTION

Protector



Optional Tool Jackets

Size	Part Number	Used for
S	10C-840-1	BP-T40(D), BP-T50(D) BP-T40(D)(RF8)/(TK), BP-T50(D)(RF8)/(TK)
	10C-840-4	
M	10E-840-1	BP-T60(D) BP-T60(D)(RF8)/(TK)
	10E-840-4	

DERIVATIVE MODELS OF BP-T SERIES [SHUT-OFF TYPE]

Wireless RF8 Type / Z(ZigBee) Type (*)

*For information on the Radio Law in your country, please contact your nearest URYU distributor.

RF8 : Pokayoke configuration

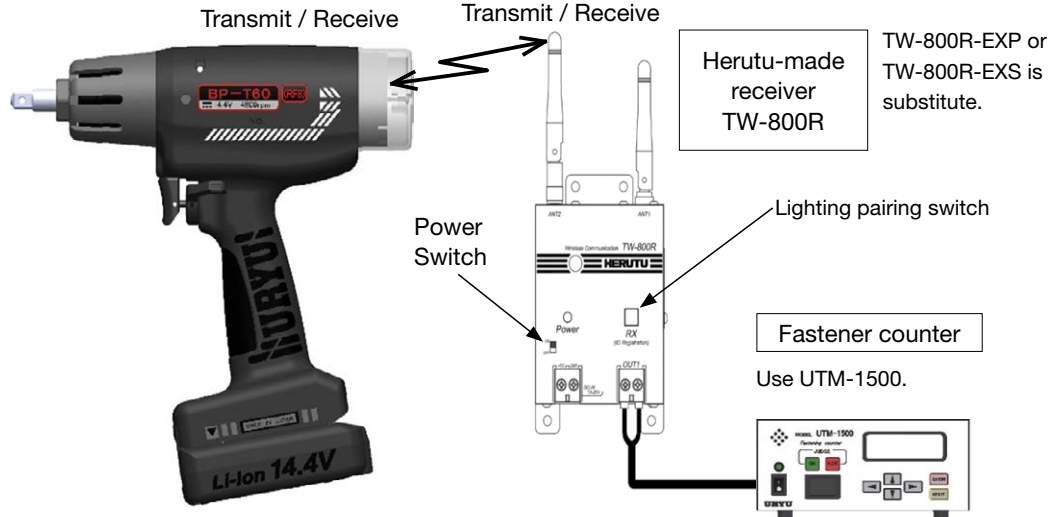

Z(ZigBee) : Pokayoke configuration

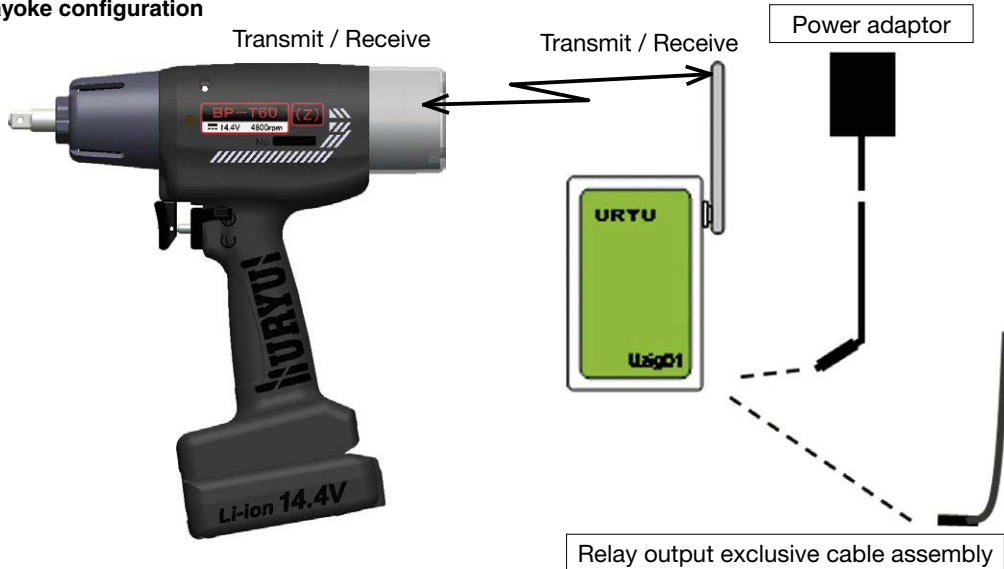

To UTM-1500 or PLC

Specifications (Shut-off Type)

Model	Capacity (Nominal Bolt Size)		Torque Range		Free Speed (Approx.)	Overall Length less Socket or Bit (Approx.)		Weight less Socket or Bit				From Center to Outside (Approx.)		Sq. Drive or Hex. Size		Battery Voltage (Capacity)	Battery Model (Panasonic)	Number of fastening per minute *	Fastener quantity per full charge	Code
	mm	in	Nm	ft-lbs		mm	in	with battery		with no battery		mm	in	mm	in					
	min ⁻¹	kg	lb	kg	lb	mm	in													
BP-T40D(RF8)	5	No. 10	4.5-8	3.3-5.9	3300	207	8 5/32	1.45	3.19	1.15	2.53	27	1 1/16	6.35	1/4	10.8V (2.0Ah)	EYFB32	11	1000	10A62
BP-T50D(RF8)	6-8	1/4-5/16	6.5-13	4.8-9.6	3900	207	8 5/32	1.45	3.19	1.15	2.53	27	1 1/16	6.35	1/4	10.8V (2.0Ah)	EYFB32	7	700	10C62
BP-T60D(RF8)	8	5/16	13-26	9.6-19.2	4800	212	8 11/32	1.60	3.52	1.25	2.75	27	1 1/16	6.35	1/4	14.4V (2.0Ah)	EYFB41	7	600	10E62
BP-T40(RF8)	5	No. 10	4.5-8	3.3-5.9	3300	204	8 1/32	1.45	3.19	1.15	2.53	27	1 1/16	9.5	3/8	10.8V (2.0Ah)	EYFB32	11	1000	10A72
BP-T50(RF8)	6-8	1/4-5/16	7-15	5.1-11.1	3900	204	8 1/32	1.45	3.19	1.15	2.53	27	1 1/16	9.5	3/8	10.8V (2.0Ah)	EYFB32	7	700	10C72
BP-T60(RF8)	8	5/16	13-26	9.6-19.2	4800	209	8 15/64	1.60	3.52	1.25	2.75	27	1 1/16	9.5	3/8	14.4V (2.0Ah)	EYFB41	7	600	10E72
BP-T40D(Z)	5	No. 10	4.5-8	3.3-5.9	3300	218	8 37/64	1.45	3.19	1.15	2.53	27	1 1/16	6.35	1/4	10.8V (2.0Ah)	EYFB32	11	1000	10B12
BP-T50D(Z)	6-8	1/4-5/16	6.5-13	4.8-9.6	3900	218	8 37/64	1.45	3.19	1.15	2.53	27	1 1/16	6.35	1/4	10.8V (2.0Ah)	EYFB32	7	700	10D12
BP-T60D(Z)	8	5/16	13-26	9.6-19.2	4800	223	8 25/32	1.60	3.52	1.25	2.75	27	1 1/16	6.35	1/4	14.4V (2.0Ah)	EYFB41	7	600	10F12
BP-T40(Z)	5	No. 10	4.5-8	3.3-5.9	3300	215	8 15/32	1.45	3.19	1.15	2.53	27	1 1/16	9.5	3/8	10.8V (2.0Ah)	EYFB32	11	1000	10B22
BP-T50(Z)	6-8	1/4-5/16	7-15	5.1-11.1	3900	215	8 15/32	1.45	3.19	1.15	2.53	27	1 1/16	9.5	3/8	10.8V (2.0Ah)	EYFB32	7	700	10D22
BP-T60(Z)	8	5/16	13-26	9.6-19.2	4800	220	8 21/32	1.60	3.52	1.25	2.75	27	1 1/16	9.5	3/8	14.4V (2.0Ah)	EYFB41	7	600	10F22

*Torque Range is a guideline value. Please make tool selection appropriately in accordance with an actual application.

*Battery or Battery Charger is not included. Please use EYOL82 (Panasonic) for Battery Charger.

*Calculated under URYU test condition. It varies depending on the usage condition.

BP-T SERIES [SHUT-OFF TYPE]

Incomplete Job Detection (TK) Type

LED with red lighting tells you incomplete job (premature trigger off)



BP-T60D (TK)

FEATURES

- Squeeze trigger, and shut-off information LED will light red.
- Switch off the trigger before automatic shut-off, and the LED will continue lighting red for 3 seconds and go out.
- The LED lights green with 1 pulse buzzer sounding for automatic shut-off.

(Note) Automatic shut-off by retry repairing incomplete job error will light LED by switching green and red together.

Quick-change driver anvil type

On pulling the sleeve, insert or take off the bit.

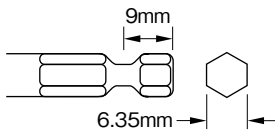

The model name suffixing (D) is the Quick-change driver anvil type.

Specifications (Shut-off Type)

Model	Capacity (Nominal Bolt Size)		Torque Range		Free Speed (Approx.)	Overall Length less Socket or Bit (Approx.)		Weight less Socket or Bit				From Center to Outside (Approx.)		Sq. Drive or Hex. Size		Battery Voltage (Capacity)	Battery Model (Panasonic)	Number of fastening per minute *	Fastener quantity per full charge	Code
	mm	in	Nm	ft-lbs	min ⁻¹	mm	in	with battery		with no battery		mm	in	mm	in					
								kg	lb	kg	lb									
BP-T40D(TK)	5	No. 10	4.5-8	3.3-5.9	3300	207	8 5/32	1.45	3.19	1.15	2.53	27	1 1/16	6.35	1/4	10.8V (2.0Ah)	EYFB32	11	1000	10A82
BP-T50D(TK)	6-8	1/4-5/16	6.5-13	4.8-9.6	3900	207	8 5/32	1.45	3.19	1.15	2.53	27	1 1/16	6.35	1/4	10.8V (2.0Ah)	EYFB32	7	700	10C82
BP-T60D(TK)	8	5/16	13-26	9.6-19.2	4800	212	8 11/32	1.60	3.52	1.25	2.75	27	1 1/16	6.35	1/4	14.4V (2.0Ah)	EYFB41	7	600	10E82
BP-T40(TK)	5	No. 10	4.5-8	3.3-5.9	3300	204	8 1/32	1.45	3.19	1.15	2.53	27	1 1/16	9.5	3/8	10.8V (2.0Ah)	EYFB32	11	1000	10A92
BP-T50(TK)	6-8	1/4-5/16	7-15	5.1-11.1	3900	204	8 1/32	1.45	3.19	1.15	2.53	27	1 1/16	9.5	3/8	10.8V (2.0Ah)	EYFB32	7	700	10C92
BP-T60(TK)	8	5/16	13-26	9.6-19.2	4800	209	8 15/64	1.60	3.52	1.25	2.75	27	1 1/16	9.5	3/8	14.4V (2.0Ah)	EYFB41	7	600	10E92

*Torque Range is a guideline value. Please make tool selection appropriately in accordance with an actual application.
 *Battery or Battery Charger is not included. Please use EY0L82 (Panasonic) for Battery Charger.
 *Calculated under URYU test condition. It varies depending on the usage condition.

OIL FILLER FOR PULSE UNIT

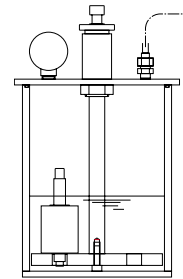
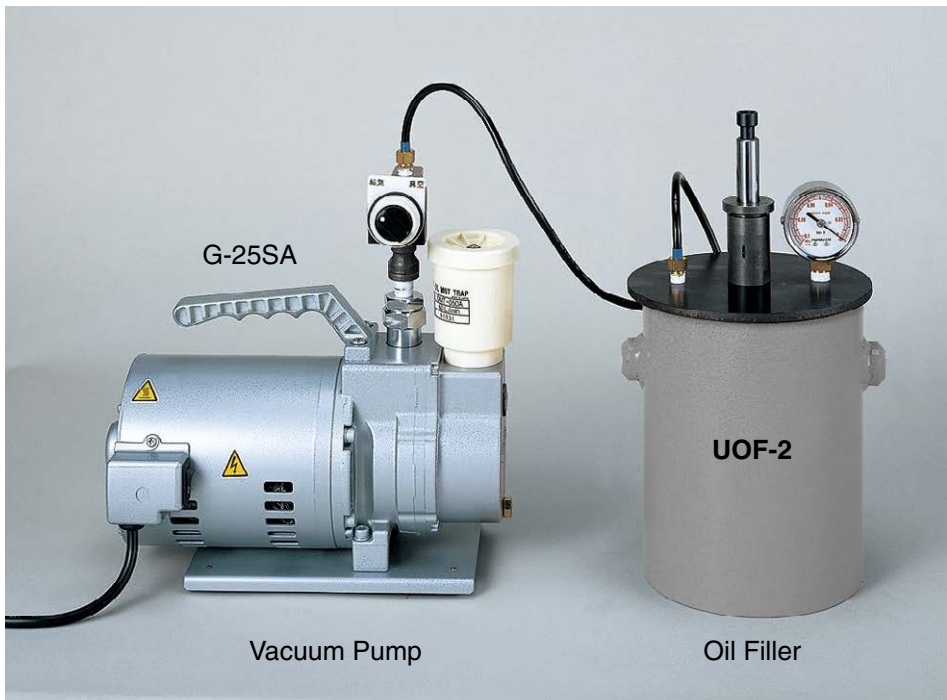

Oil Fluid	Q'ty	Part Number
Hyrando Jinen TX46	20L	998-735-0

FEATURES

The new **UOF-2** eliminates troublesome process of oil-filling procedure repeated at previous model UOF-1 due to employment of the powerful vacuuming system.

Use Hyrando Jinen TX46 and do not substitute any other fluid.

You can choose the Oil Filler from the below choices.

Part Number	Description
878-945-1	Complete Set for Oil Filler (with Vacuum Pump and Oil Filler Tank)
878-955-1	Oil Filler without Vacuum Pump

Electric control system

SUPER "INTELEC" SERIES

URYU Electric control system series running with more precise control meets a scene requiring accurate and delicate control.

POINT 1

Control a tool easily by a controller.

- Programming is easy on front panel. You can also upload your program from PC. (The exclusive setup software is necessary)
- Counting a number of fastener and various error detection functions are equipped.
- Controller meets various work condition, maximum 16 different kinds works can be set. (maximum 8 different kinds works for UECP-4900 & UEC-5500)
- A fastening number and a pulse number can be controlled.
- Fastening torque result and torque waveform can be shown.
- Standard deviations, Cp value, Cpk value can be analyzed instantly from the stored data within the controller and you can graph the statistical data.
- Check of Input/Output and display of errors can be confirmed with beep sound and display on PC or Front panel of controller. (For touch panel type only)

POINT 2

Function on setup software with PC.

- Transmit and receive setting values
- Receive and store fastening results
- Receive and store waveform data
- Receive and store statistical data
- I / O check

POINT 3

Self-checking function

When the power turns on, self-checking function automatically runs as ROM → RAM → A/D → Filter Check → ZERO CAL Check and etc.

POINT 4

Ethernet (TCP/IP) capable

- When the dedicated setup software is installed to PC, setting parameters can be transmitted and received between controller and PC, fastening result/waveform data can be received from controller.
- When a controller is connected with a host computer to control an assembly line, the controller receive a fastening instruction from the host computer and return the fastening result with the instruction to host computer.

Controller \ Tool	UBX-AF SERIES ▶ P.12	UCX-AF SERIES ▶ P.21	UDP-MC SERIES ▶ P.23	UAAMC SERIES ▶ P.28	UAMC SERIES ▶ P.30	UXR-MC SERIES ▶ P.31
UECP-4900 SERIES ▶ P.20	—	●	—	—	—	—
UECP-4811 SERIES ▶ P.22	—	—	●	—	—	—
UEC-4801 SERIES ▶ P.25	—	—	—	●	●	●
UEC-5500 SERIES ▶ P.26	*●	—	—	—	●	●

*URYU UZig01 coordinator is required.

UECP SERIES

UECP-4900

Multifunction Controller to drive and control UCX-AF series

BOLT & NUT SETTERS



*Joint Cable Assembly is necessary to connect a UCX-AF tool with controller.
910-727-0: 5M / 910-728-0: 10M

UECP-4900	UCX-AF Series
-----------	---------------

UECP SERIES SPECIFICATIONS

MODEL	UECP-4900A	UECP-4900E
POWER SUPPLY	AC100-115V	AC230V
POWER FREQUENCY	50 / 60 Hz	
INSULATION PROTECTION	DC500V over 10MΩ	
AMBIENT TEMPERATURE	0~50°C (non-freezing)	
AMBIENT HUMIDITY	Under 85% RH (no dew)	
WEIGHT	4.2 kg	11.0 kg
DIMENSIONS	303 (D) × 220 (W) × 146.5 (H)	303 (D) × 220 (W) × 213.5 (H)
MAIN FUNCTIONS	Torque Control / Angle Monitoring / Fastening Counter	
PARAMETER SETUP	Manual Input on Front Touch Panel / Personal Computer (with setup software)	
DISPLAY	3.5-inch LCD (320×240 dot) Touch panel TFT color	
INPUT TERMINAL SIGNAL	Operation Voltage / Current: DC24V / approx. 10mA (NPN ↔ PNP changeable), 6 Terminals (free format) Note: Contact input necessary	
OUTPUT TERMINAL SIGNAL	Contact Capacity: DC30V, 1A, 6 Terminals (free format)	
OPTION	Setting PC Cable (Straight) Part Number : 910-219-0	
CODE (A/E)	81932	81942



UECP-4900A



UECP-4900E

UECP-4900 Series System Layout

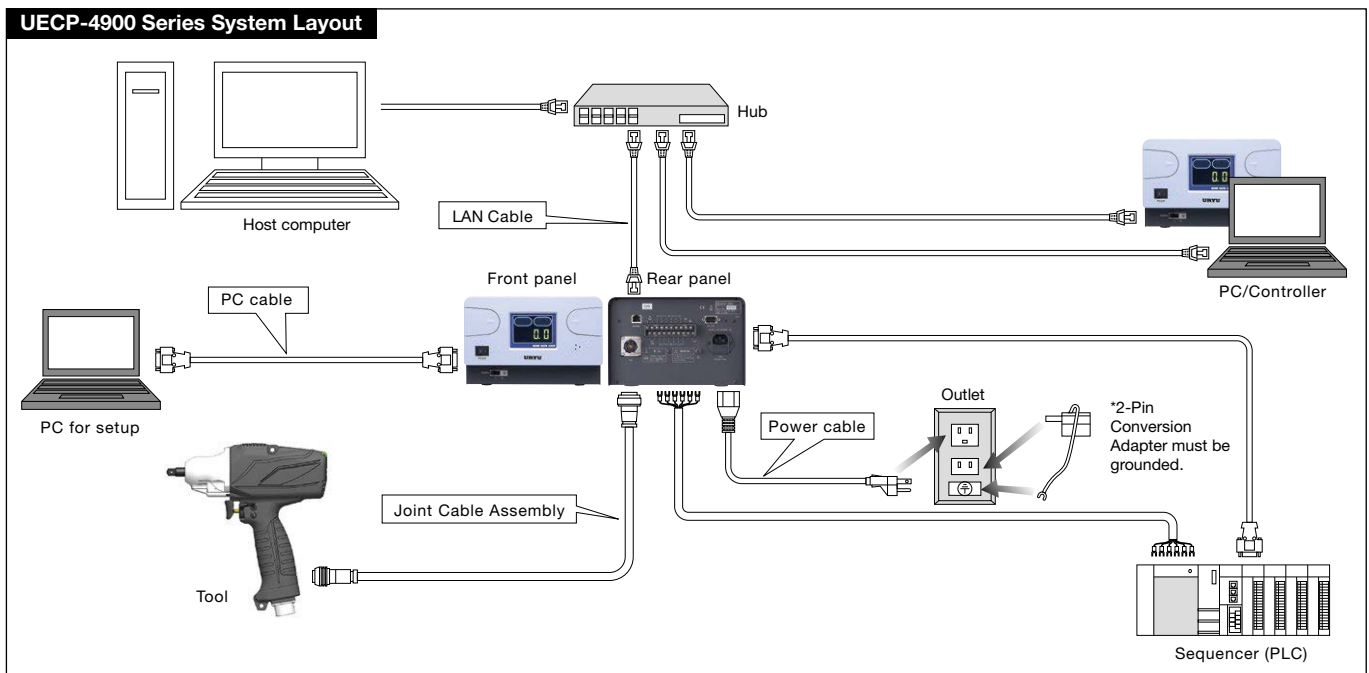

UCX-AF SERIES

Further evolved Electric Oil-Pulse Tool with PHOENIX pulse



UCX-AF900



UCX-AF600



UCX-AF600L



UCX-AF700

BOLT & NUT SETTERS

FEATURES

- Newly developed Phoenix pulse increases output and improves durability.
- More compact and lightweight compared with conventional model
- Increased number of fastening per minute by improved cooling effect
- UCX-AF series are capable of monitoring fastening angle with the equipped ultra-slim Encoder.
- Further improved accuracy (approximately twice the conventional tightening) with a newly equipped [Zoomed-Step Fastening] function.

SPECIFICATIONS

Model	Capacity (Nominal Bolt Size)		Torque Range		Free Speed (Approx.)	Overall Length less Socket (Approx.)		Weight less Socket (Approx.)		From Center to Outside (Approx.)		Sq. Drive Shank		Number of fastening per minute*	Code
	mm	in	Nm	ft-lbs	min ⁻¹	mm	in	kg	lb	mm	in	mm	in		
UCX-AF600L	5-8	No.10-5/16	4.0-20.0	3.0-14.8	4800	203	7 63/64	1.50	3.31	27.5	1 5/64	9.5	3/8	12	12U02
UCX-AF600	6-10	1/4-3/8	10.0-40.0	7.4-29.6	4800	203	7 63/64	1.50	3.31	27.5	1 5/64	9.5	3/8	10	12U12
UCX-AF700	8-12	5/16-1/2	20.0-60.0	14.8-44.4	4800	203	7 63/64	1.55	3.42	27.5	1 5/64	9.5	3/8	9	12U22
UCX-AF900	10-12	3/8-1/2	30.0-72.0	22.1-53.1	4800	221	8 45/64	1.76	3.88	27.5	1 5/64	12.7	1/2	7	12U42

*Torque Range is a guideline value. Please make tool selection appropriately in accordance with an actual application.
 *Calculated under URYU test condition. It varies depending on the usage condition.

UECP SERIES

Multifunction Controller to drive and control UDP-MC series

BOLT & NUT SETTERS



*Joint Cable Assembly is necessary to connect tool with controller
 For UDP-A600LMC · A700MC · A100MC 910-807-0: 5M / 910-808-0: 10M / 910-809-0: 15M / 910-810-0: 20M
 For UDP-A120MC 910-567-0: 5M / 910-568-0: 10M / 910-569-0: 15M / 910-625-0: 20M

UECP SERIES SPECIFICATIONS

POWER SUPPLY	UECP-4811A: AC115V UECP-4811E: AC230V
POWER FREQUENCY	50 / 60 Hz
NOISE PROTECTION	1000V 1μS (according to noise simulator)
INSULATION PROTECTION	DC500V over 10MΩ
AMBIENT TEMPERATURE	0~50°C (non-freezing)
AMBIENT HUMIDITY	90% RH or less (no dew)
WEIGHT	11.30 kg
DIMENSIONS	265 (D) × 222 (W) × 200 (H)
MAIN FUNCTIONS	Torque control, Fastener number count
PARAMETER SETUP	Manual input on front LCD panel By PC (with setup software)
DISPLAY	Torque resolution ±2048 (12 bit by A/D use)
	LCD type LCD (20 letters × 4 lines)
	Work number, Bolt count number, Tightening time and Pulse blow number 1-digit Digital Display (DPM) Work number displayed 4-digit Digital Display (DPM) Torque reading displayed
LED	Total Lamp (for Count Judgment) : OK (green) / NOK (red)
	Torque Lamp (for Torque Judgment) : LOW (yellow) / OK (green) / HIGH (red)
INPUT TERMINAL SIGNAL	Operation Voltage/Current : DC24V / about 10mA 6 terminals available (programmable) Note: Contact input necessary
OUTPUT TERMINAL SIGNAL	Contact Capacity : DC30V, 1A 6 terminals available (programmable), VALVE
OPTION	Setting PC Cable (Straight) Part Number : 910-219-0
CODE (A/E)	81972/81982

UECP-4811 | UDP-A600LMC · A700MC · A100MC · A120MC Series

UECP Series System Layout

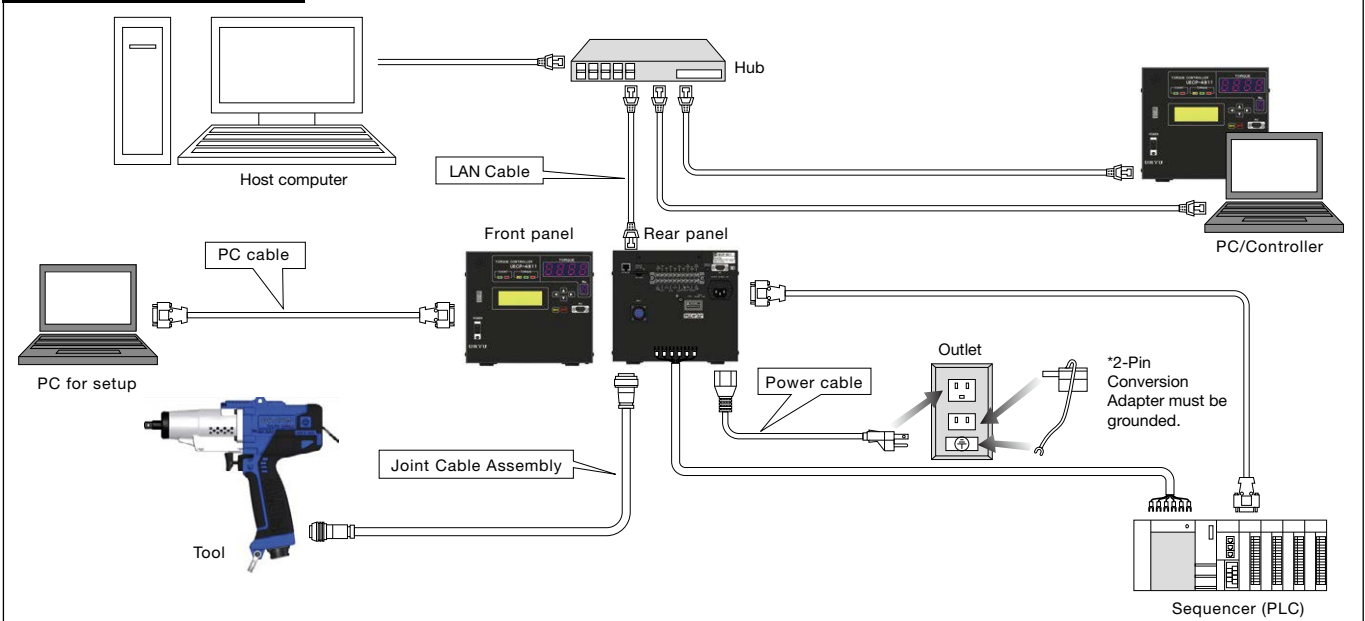

UDP-MC SERIES

**Exquisite Range of Torque.
Fastening with high efficiency & high accuracy.
New Function: Double hitting error detection function available.
External start signal available for multi-purpose usage.**



UDP-A700MC



UDP-A600LMC



UDP-A100MC
UDP-A120MC



Top Load Type
UDP-A600LMC (TL)

FEATURES

- URYU's unique non-contact Magnetostrictive transducer incorporated.
- The UDP tool is driven by commercial electricity. This helps you build an assembly line easily and adjust it flexibly to the layout change.
- High Power and High efficiency adopted by IPM motor. (except for A100MC/A120MC)
- Cooling fan is activated automatically when pulling the throttle trigger, which contributes to heat reduction and increase number of fastening.
- The intelligence of UDP-MC tool stops operation immediately to protect the operator from the failure including overloaded operation, short circuit, and broken wire, which minimizes the possible influence over operator and shop floor.

[FUNCTIONS]

- Motor speed/current is programmable.
 - Motor current can be set in 4 steps
 - Motor rotational speed can be set in 100 min⁻¹ increments (by the 2-step fastening, torque spike at bolt seating is inhibited, and make it possible to cover the wider torque range.)
- The functions of various fastening error detections and fastener number count down assure your operations.
- Makes setup or changeover of fastening torque and fastening number count.
- Tool's maintenance is possible by counting both total cycle numbers (how many fasteners) and/or total pulse numbers.
- Input/Output check and error messages can be checked from your PC screen or the front panel of UECP Series with buzzer sounding.
- Can set up and monitor various control values and setting values either on the front panel or on your PC screen.
- Ethernet(TCP/IP) capable. Upload and receipt of the setting values, upload of the fastening result/waveform data through PC software.

Electric Oil-Pulse Tool UDP-MC Series

Model	Capacity (Nominal Bolt Size)		Torque Range		Free Speed (Approx.) min ⁻¹	Overall Length (Approx.)		Weight less Socket (Approx.)		From Center to Outside (Approx.)		Sq. Drive Shank		Code	
	mm	in	Nm	ft-lbs		mm	in	kg	lb	mm	in	mm	in	Standard	TL
UDP-A600LMC, (TL)	5-6	No.10-1/4	4.0-20.0	3.0-14.8	4800	214	8 27/64	1.53	3.37	29.5	1 5/32	9.5	3/8	07452	07459
UDP-A700MC, (TL)	8-12	5/16-1/2	10.0-50.0	7.4-37.0	4800	242	9 33/64	1.78	3.92	29.5	1 5/32	9.5	3/8	07332	07339
UDP-A100MC, (TL)	10-12	3/8-1/2	45.0-100.0	33.3-74.0	4800	248	9 49/64	2.85	6.27	34.5	1 23/64	12.7	1/2	07382	07389
UDP-A120MC, (TL)	12-14	1/2-9/16	55.0-120.0	40.5-88.4	4800	248	9 49/64	2.85	6.27	34.5	1 23/64	12.7	1/2	07402	07409

Model name with "TL" is top load type.

*Torque Range is a guideline value. Please make tool selection appropriately in accordance with an actual application.

UEC SERIES (Single Spindle Connection)

UEC-4801 / UEC-4801 (ANGLE)

Cost-Effective LCD-Panel Available



FEATURES

- Ethernet(TCP/IP) capable.
- You can detect various fastening errors and control the job with fastening counter.
- UEC-4801 Series can be used for 16 different fastening applications.
- Front panel, PC display or buzzer will tell you Input/Output (terminal blocks & tool wiring) checks and errors.
- UEC-4801 Series memorizes max. 4,550 fastening data (max. 1,900 fastening data when ID data is included). Standard deviations, Cp value, Cpk value can be analyzed instantly from the stored data within the controller. When you connect UEC-4801 Series to PC, you can graph the statistical data.
- By using Input/Output terminals UEC-4801 Series can be interlocked with the production line.
- Setting parameters can be put into the controller on the front panel as well as PC.

SPECIFICATIONS

Models	UEC-4801A/E	UEC-4801A/E (ANGLE)
POWER SUPPLY	AC100~240V ±10%	
POWER FREQUENCY	50/60 Hz	
NOISE PROTECTION	1000V 1μS (according to noise simulator)	
INSULATION PROTECTION	DC500V over 10MΩ	
AMBIENT TEMPERATURE	0~50°C (non-freezing)	
AMBIENT HUMIDITY	Under 90%RH (no dew)	
POWER CONSUMPTION	Approx. 30VA	
WEIGHT	Approx. 3.6 kg	
DIMENSIONS	265(D) x 222(W) x 120(H)	
MAIN FUNCTIONS	Torque Control + Fastening Counter	
ANGLE MONITORING	—	○
PARAMETER SETUP	Manual Input on Front LCD Panel	
	Personal Computer (with setup software)	
DISPLAY	Torque Resolution ±2048 (12Bit A/D) LCD : 20 characters x 4 lines Contents : WORK NO. / FASTENING COUNT DOWN NO. / FASTENING TIME / PULSE NO. 1-digit digital display (DPM) : WORK NO. 4-digit digital display (DPM) : TORQUE	
LED	COUNT Lamp : OK (Green) / NOK (Red) TORQUE Lamp : LOW (Yellow) / OK (Green) / HIGH (RED)	
INPUT TERMINAL SIGNAL	Operation Voltage/Current : DC24V/aprox. 10mA 6 terminals (free format), VALVE	
OUTPUT TERMINAL SIGNAL	Contact Capacity : AC:125V, 0.3A, DC:30V, 1A 6 terminals (free format), VALVE	
OPTION	Setting PC Cable (Straight) Part Number : 910-219-0	
CODE (A/E)	81B42/81B52	81C42/81C52

Used with

Magnetostrictive Sensor Pulse Wrench	UAAMC Series / UAMC Series / UXR-MC Series
Strain-Gauge Sensor Pneumatic Nutrunner	UAN-RM Series

UEC-4801 Series System Layout

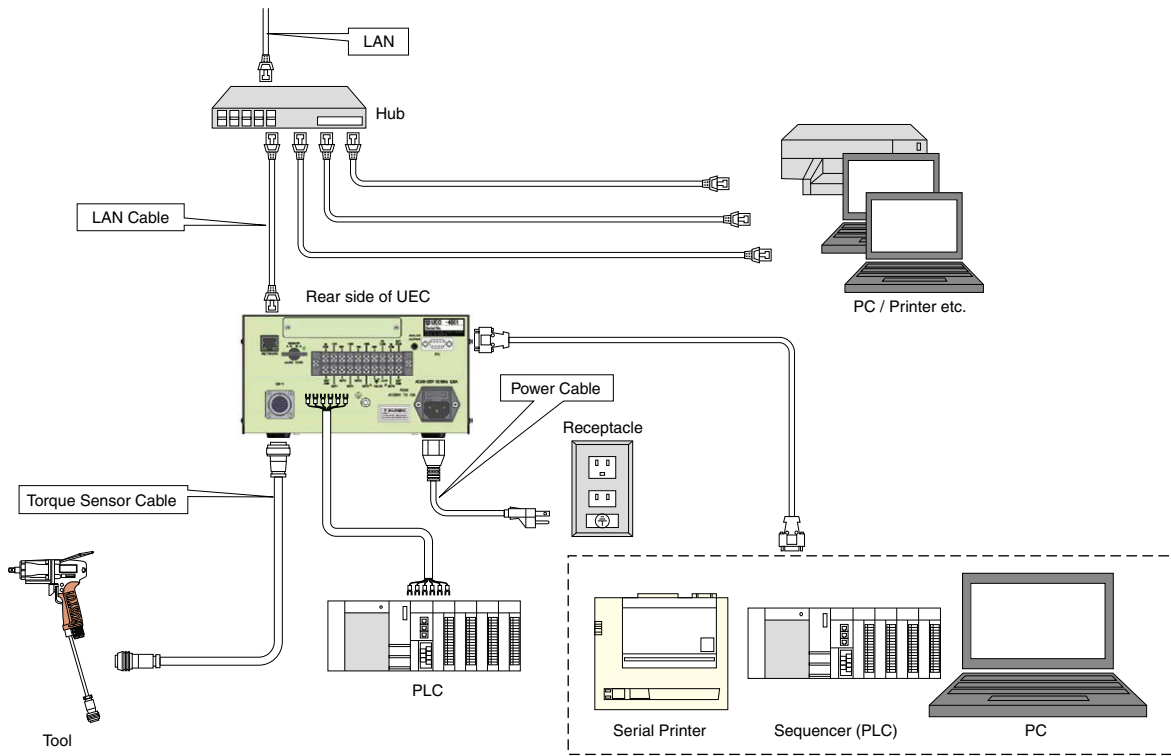

UEC SERIES (Multi Spindle Connection)

UEC-5500

Multi-function controller which can control 4-spindles simultaneously. UEC-5500 controls various error detections, the number of fasteners and pulse numbers for 4 different tools in one controller.



Used with

Magnetostrictive Sensor Pulse Wrench	UAMC Series / UXR-MC Series
Strain-Gauge Sensor Pneumatic Nutrunner	UAN-RM Series

*Key Pad (910-208-0) and Key Pad Cable (910-206-0) are optional items, so please purchase them separately.

FEATURES

- UEC-5500 can control max. 4 different transducerized tools simultaneously.
- UEC-5500 can be used with various type of transducerized tools.
Oil-Pulse Tools fitted with a brushless type Magnetostrictive Transducer.
UAMC Series, UXR-MC Series
Pneumatic Nutrunners fitted with a Strain-Gauged Transducer.
UAN-RM Series
- High Reliable Torque Control & Monitor.
- Easy Programming with a Removable Key Pad. You can also upload the fastening programmes from PC.
- Ethernet(TCP/IP) capable.

[FUNCTIONS]

- You can choose between Torque Control and Monitor. You can detect various errors and control the job with fastening counter.
- You can see 'Torque wave Data' on PC.
- Makes setup or changeover of fastening torque and fastening number count for 8 different fastening applications.
- Input/Output check and error messages can be checked from your PC screen or the front panel of UEC-5500 with buzzer sounding.
- For Oil-Pulse Tools, tool maintenance can be determined by the total numbers of fasteners as well as total pulse numbers.
- UEC-5500 memorizes max. 20,000 fastening data per spindle. By connecting to PC, you can download the stored data to your PC for statistical analysis of mean, σ , 3σ / mean, CP, and CPK. You can also graph the statistical data.
- By using Input / Output terminals UEC-5500 can be interlocked with the production line.

UEC-5500A/E SPECIFICATIONS

POWER SUPPLY	AC100~240V ±10%
POWER FREQUENCY	50 / 60 Hz
NOISE PROTECTION	1000V 1μS (according to noise simulator)
INSULATION PROTECTION	DC500V over 10MΩ
AMBIENT TEMPERATURE	0~50°C (non-freezing)
AMBIENT HUMIDITY	Under 90%RH (no dew)
POWER CONSUMPTION	Approx. 50VA
WEIGHT	Approx. 3.6 kg
DIMENSIONS	240(D) × 270(W) × 115(H)
MAIN FUNCTIONS	Torque Monitoring / Control + Fastening Counter
PARAMETER SETUP	Removable Key Pad Personal Computer (with setup software)
DISPLAY	Torque Resolution ±2048 (12Bit A/D)
	4-digit digital display : TORQUE
	2-digit digital display : FASTENING COUNT DOWN NO.
	1-digit digital display (small) × 4 : WORK NO. 1-digit digital display (large) × 4 : SPINDLE NO.
LED	Each Spindle's COUNT Lamp : OK (Green) / NOK (Red) TORQUE Lamp : LOW (Yellow) / OK (Green) / HIGH (RED)
INPUT TERMINAL SIGNAL	Drive by Electric Current Input (Photo Coupler Insulation) Voltage : DC24V Insulation Resistance : 4.7KΩ 12 terminals (free format)
OUTPUT TERMINAL SIGNAL	Contact Capacity : AC:125V, 0.3A, DC:30V, 1A 8 terminals (free format), VALVE, +24V
OPTION	Setting PC Cable(Straight) Part Number : 910-219-0
CODE (A/E)	83272/83292

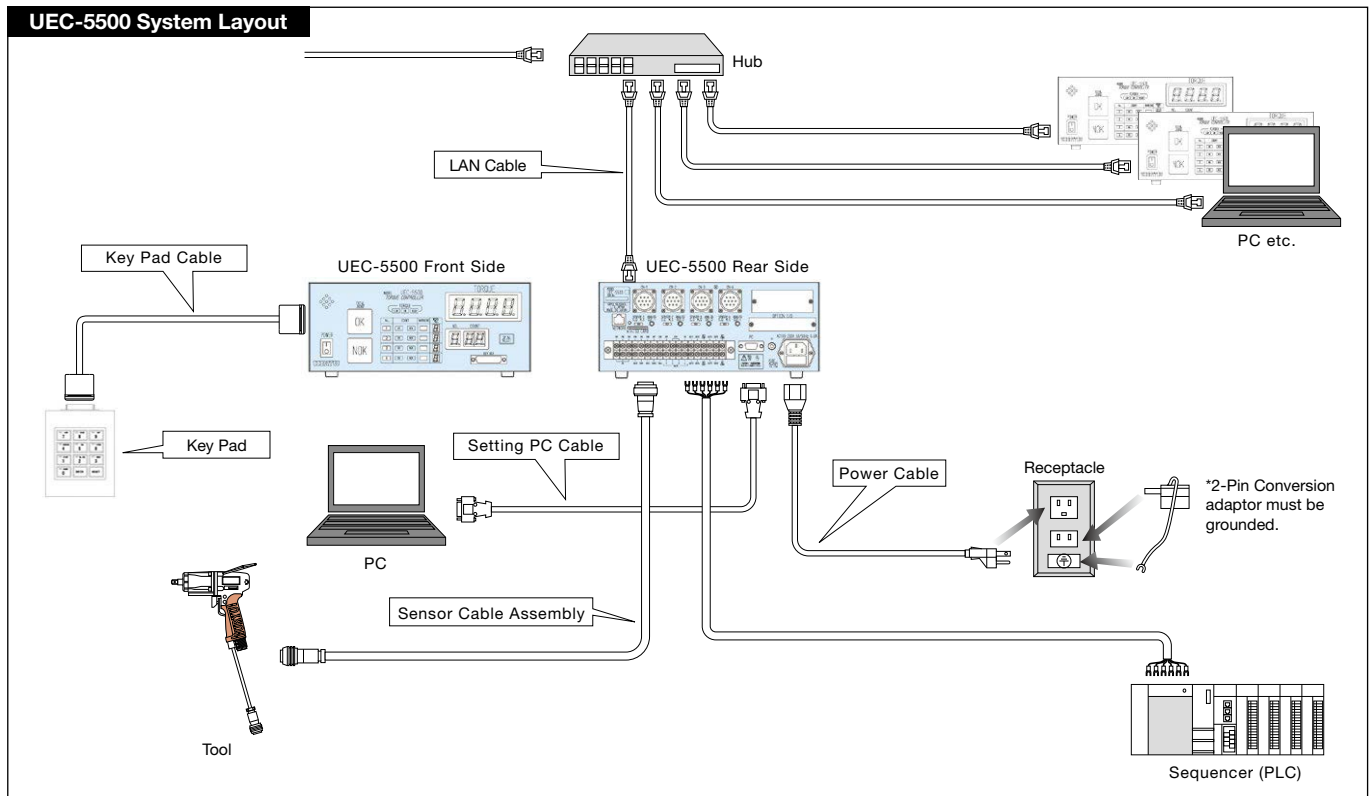

UAAMC SERIES

Various fastening errors such as double-hit, cross-thread, foreign objects insertion are detectable. Fastening quality improved by angle monitoring function provides you with enhanced reliability.



UA400AMC



UA500AMC



UA600AMC



UA700AMC



UA1300AMC

FEATURES

- UAAMC series are capable of angle monitoring in addition to the torque control/monitoring from UAMC series. It enables you to get double-hit, cross-thread, foreign object insertion and so forth by angle monitoring, and improve the fastening quality.

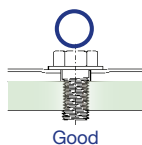

Good

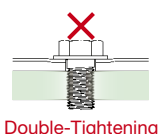

Double-Tightening

Double-Tightening :

Detectable as the torque increases, while the free run angle lacks.

- Free Run Angle NG

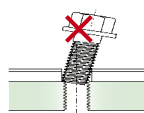

Cross Thread

Cross Thread :

Detectable as the fastening angle gets too high.

- Angle NG

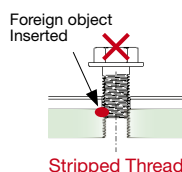

Stripped Thread

Stripped Thread/Seized Thread :

Detectable as the torque does not increase and the fastening angle gets too high.

- Angle NG

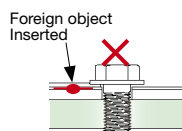

Seized Thread

Foreign Object Inserted :

Detectable as the torque does not increase and the fastening angle gets too high.

- Angle NG

SPECIFICATIONS

Recommended Air Pressure: 0.4MPa (57psi) - 0.6MPa (85psi)

Model	Capacity (Nominal Bolt Size)		Torque Range						Free Speed (Approx.) min ¹			Overall Length (about)		Weight less Socket (about)		From Center to Outside (about)		Sq. Drive Shank		Average Air Consumption		Code
			0.4MPa		0.5MPa		0.6MPa															
	mm	in	Nm	ft-lbs	Nm	ft-lbs	Nm	ft-lbs	0.4MPa	0.5MPa	0.6MPa	mm	in	kg	lb	mm	in	mm	in	m ³ /min	ft ³ /min	
UA400AMC	6	1/4	4.0-9.0	2.9-6.6	5.0-11.0	3.7-8.1	7.0-13.0	5.1-9.6	2800	3000	3200	193.0	7 19/32	1.35	2.97	28.0	1 7/64	9.5	3/8	0.20	7.0	17G02
UA500AMC	6-8	1/4-5/16	8.0-18.0	5.9-13.3	9.0-20.0	6.6-14.8	11.0-25.0	8.1-18.5	3400	3600	3800	193.0	7 19/32	1.35	2.97	28.0	1 7/64	9.5	3/8	0.25	8.8	17G12
UA600AMC	8	5/16	14.0-26.0	10.3-19.2	16.0-30.0	11.8-22.2	18.0-38.0	13.3-28.1	3900	4100	4300	198.5	7 13/16	1.4	3.08	28.0	1 7/64	9.5	3/8	0.40	14.0	17G22
UA700AMC	8-10	5/16-3/8	20.0-35.0	14.8-25.9	25.0-40.0	18.5-29.6	30.0-50.0	22.2-37.0	5700	5900	6200	207.5	8 11/64	1.5	3.3	28.5	1 1/8	9.5	3/8	0.45	15.8	17G32
UA800AMC *	10-12	3/8-1/2	30.0-45.0	22.2-33.3	35.0-50.0	25.9-37.0	40.0-60.0	29.6-44.4	4800	5000	5300	215.5	8 31/64	1.7	3.74	29.0	1 9/64	9.5	3/8	0.48	16.8	17G42
UA900AMC	10-12	3/8-1/2	30.0-55.0	22.2-40.7	35.0-65.0	25.9-48.1	40.0-80.0	29.6-59.2	4800	5000	5300	227.5	8 61/64	2.15	4.73	28.0	1 7/64	12.7	1/2	0.53	18.6	17G82
UA1000AMC	12	1/2	40.0-70.0	29.6-51.8	45.0-75.0	33.3-55.5	50.0-90.0	37.0-66.6	4600	4800	5000	235.0	9 1/4	2.45	5.39	30.0	1 3/16	12.7	1/2	0.55	19.3	17G92
UA1300AMC	14	9/16	65.0-95.0	48.1-70.3	70.0-130.0	51.8-96.2	85.0-150.0	62.9-111.0	4200	4400	4600	256.5	10 3/32	3.25	7.15	36.0	1 27/64	12.7	1/2	0.73	25.6	17H02

Air Inlet size : NPT1/4" Air Hose size : 10mm×6.5mm×5m for UA400AMC and UA500AMC 12mm×8.0mm×5m for UA600AMC~UA1000AMC 16mm×11.0mm×5m for UA1300AMC

*Please refrain from using UA800AMC at around max. torque as it is developed to aim at torque output between UA700AMC and UA900AMC.

*Torque Range is a guideline value. Please make tool selection appropriately in accordance with an actual application.

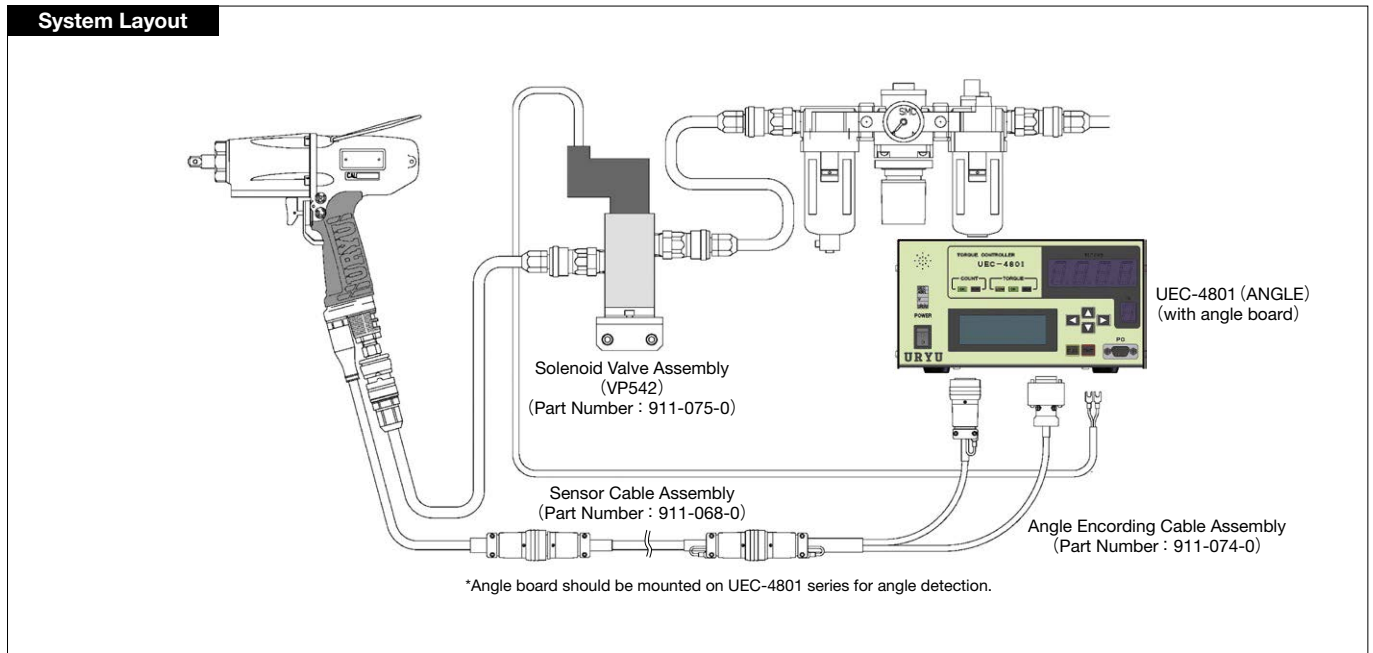

OPTION

Cable Hose Assembly

Cable Hose Assembly is a combination hose of Air Hose and Sensor Cable Assembly which can be used for the connection between MC/EC wrench and Controller/Solenoid Valve Assembly.

Please ask your local URYU distributor for details of corresponding models, size, hose inside diameter and so on.

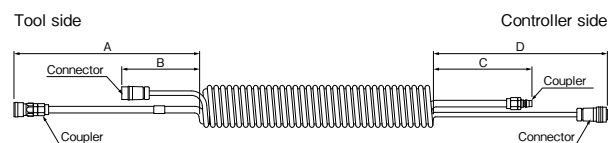

Parts Name	Part Number	Hose Color	Dimensions (mm)						Hose inside Diameter (mm)
			A	B	Maximum Coiled Range of use	Minimum Coiled Length	C	D	
Cable Hose Assembly $\phi 12 \times \phi 45 \times 27$ (R) 1.1	935-280-0	Red	1300	1100	2200	350	300	500	8
Cable Hose Assembly $\phi 12 \times \phi 75 \times 38$ (GR)	935-276-0	Gray	400	200	5800	480	200	400	8
Cable Hose Assembly $\phi 12 \times \phi 45 \times 28$ (GR)	935-275-0	Gray	1000	700	2400	370	300	500	8

UAMC SERIES

In pursuit of high-efficiency, high-accuracy and durability, we have adopted auto-relief function*, which shortens the fastening time and improve the fastening efficiency.

BOLT & NUT SETTERS



UA40MC



UA70SMC



UA50MC



UA60MC



UA150MC



UA40SMC



UA50SMC



UA60SMC

FEATURES

- In addition to the protective handgrip, full-cover Tool Jacket is equipped as standard, which protects tools and reduces the damage to the work.
- Ergonomic light weight & compact design ensures less operators fatigue.

System Layout

When not using terminal (UEC-4801)

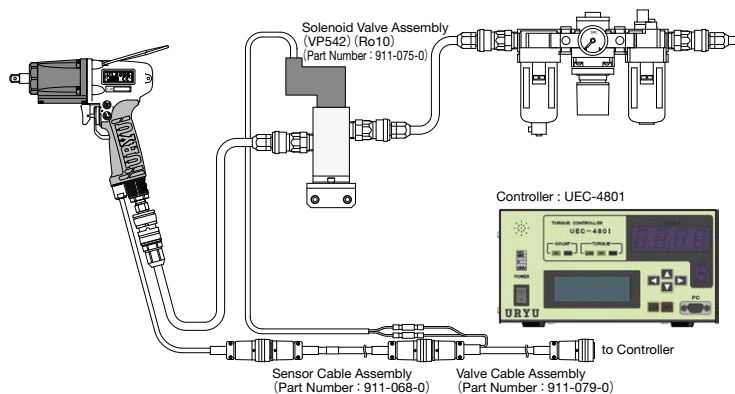

Quick-change driver anvil type

On pulling the sleeve, insert or take off the bit.

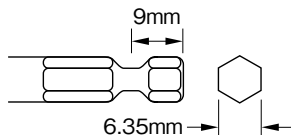

The model name suffixing (D) is the Quick-change driver anvil type.

SPECIFICATIONS (PISTOL TYPE)

Recommended Air Pressure: 0.4MPa (57psi) - 0.6MPa (85psi)

Model	Capacity (Nominal Bolt Size)		Torque Range						Free Speed (Approx.) min ⁻¹			Overall Length (about)		Weight less Socket or Bit (about)		From Center to Outside (about)		Sq. Drive or Hex. Size		Average Air Consumption		Code
			0.4MPa		0.5MPa		0.6MPa															
	mm	in	Nm	ft-lbs	Nm	ft-lbs	Nm	ft-lbs	0.4MPa	0.5MPa	0.6MPa	mm	in	kg	lb	mm	in	mm	in	m ³ /min	ft ³ /min	
UA40MC	6	1/4	4.0-9.0	2.9-6.6	5.0-11.0	3.7-8.1	7.0-13.0	5.1-9.6	3000	3300	3600	170	6 11/16	1.1	2.42	26	1 1/32	9.5	3/8	0.20	7.0	17B32
UA40DMC	6	1/4	3.5-7.5	2.5-5.5	4.5-9.5	3.3-7.0	5.0-12.0	3.7-8.8	3000	3300	3600	170	6 11/16	1.1	2.42	26	1 1/32	6.35	1/4	0.20	7.0	17B12
UA50MC	6-8	1/4-5/16	8.0-18.0	5.9-13.3	9.0-20.0	6.6-14.8	11.0-25.0	8.1-18.5	3800	4100	4200	170	6 11/16	1.1	2.42	26	1 1/32	9.5	3/8	0.25	8.8	17C42
UA50DMC	6-8	1/4-5/16	7.0-15.0	5.1-11.1	8.0-18.0	5.9-13.3	9.0-23.0	6.6-17.0	3800	4100	4200	170	6 11/16	1.1	2.42	26	1 1/32	6.35	1/4	0.25	8.8	17C22
UA60MC	8	5/16	14.0-26.0	10.3-19.2	16.0-30.0	11.8-22.2	18.0-38.0	13.3-28.1	4700	4900	5000	175	6 57/64	1.14	2.51	26	1 1/32	9.5	3/8	0.40	14.0	17D32
UA70MC	8-10	5/16-3/8	20.0-35.0	14.8-25.9	25.0-40.0	18.5-29.6	30.0-50.0	22.2-37.0	5000	5300	5700	187	7 23/64	1.24	2.73	26	1 1/32	9.5	3/8	0.45	15.8	17E02
UA80MC*	10-12	3/8-1/2	30.0-45.0	22.2-33.3	35.0-50.0	25.9-37.0	40.0-60.0	29.6-44.4	5300	5600	6000	195	7 43/64	1.55	3.41	26	1 1/32	9.5	3/8	0.48	16.8	17E52
UA90MC	10-12	3/8-1/2	30.0-55.0	22.2-40.7	35.0-65.0	25.9-48.1	40.0-80.0	29.6-59.2	5300	5600	6000	203	7 63/64	1.7	3.74	28	1 7/64	12.7	1/2	0.53	18.6	17E92
UA100MC	12	1/2	40.0-70.0	29.6-51.8	45.0-75.0	33.3-55.5	50.0-90.0	37.0-66.6	4600	4900	5200	215	8 15/32	2.05	4.51	30	1 3/16	12.7	1/2	0.55	19.3	17F32
UA130MC	14	9/16	65.0-95.0	48.1-70.3	70.0-130.0	51.8-96.2	85.0-150.0	62.9-111.0	3800	4000	4500	233	9 11/64	2.8	6.16	36	1 27/64	12.7	1/2	0.73	25.6	17F72
UA150MC	16	5/8	120.0-180.0	88.8-133.2	140.0-200.0	103.6-148.0	150.0-220.0	111.0-162.8	4000	4100	4300	251	9 7/8	4.0	8.80	40	1 37/64	19.0	3/4	0.70	24.7	17M02

Air Inlet size : NPT1/4" Air Hose size : 10mm×6.5mm×5m for UA40MC~50MC 12mm×8.0mm×5m for UA60MC~100MC 16mm×11.0mm×5m for UA130MC and UA150MC

*Please refrain from using UA80MC at around max. torque as it is developed to aim at torque output between UA70MC and UA90MC.

*Torque Range is a guideline value. Please make tool selection appropriately in accordance with an actual application.

SPECIFICATIONS (STRAIGHT TYPE) OK / NOK LED indicator equipped.

Recommended Air Pressure: 0.4MPa (57psi) - 0.6MPa (85psi)

Model	Capacity (Nominal Bolt Size)		Torque Range						Free Speed (Approx.) min ⁻¹			Overall Length (about)		Weight less Socket or Bit (about)		From Center to Outside (about)		Sq. Drive or Hex. Size		Average Air Consumption		Code
			0.4MPa		0.5MPa		0.6MPa															
	mm	in	Nm	ft-lbs	Nm	ft-lbs	Nm	ft-lbs	0.4MPa	0.5MPa	0.6MPa	mm	in	kg	lb	mm	in	mm	in	m ³ /min	ft ³ /min	
UA40SMC	6	1/4	4.0-9.0	2.9-6.6	5.0-11.0	3.7-8.1	7.0-13.0	5.1-9.6	3000	3300	3600	246	9 11/16	1.22	2.68	26	1 1/32	9.5	3/8	0.20	7.0	17H22
UA40SDMC	6	1/4	3.5-7.5	2.5-5.5	4.5-9.5	3.3-7.0	5.0-12.0	3.7-8.8	3000	3300	3600	246	9 11/16	1.22	2.68	26	1 1/32	6.35	1/4	0.20	7.0	17J22
UA50SMC	6-8	1/4-5/16	8.0-18.0	5.9-13.3	9.0-20.0	6.6-14.8	11.0-25.0	8.1-18.5	4500	4700	5000	246	9 11/16	1.23	2.70	26	1 1/32	9.5	3/8	0.25	8.8	17H32
UA50SDMC	6-8	1/4-5/16	7.0-15.0	5.1-11.1	8.0-18.0	5.9-13.3	9.0-23.0	6.6-17.0	4500	4700	5000	246	9 11/16	1.23	2.70	26	1 1/32	6.35	1/4	0.25	8.8	17J32
UA60SMC	8	5/16	14.0-26.0	10.3-19.2	16.0-30.0	11.8-22.2	18.0-38.0	13.3-28.1	4000	4200	4400	252	9 61/64	1.30	2.86	26	1 1/32	9.5	3/8	0.40	14.0	17H42
UA60SDMC	8	5/16	12.0-24.0	8.8-17.7	14.0-27.0	10.3-19.9	16.0-34.0	11.8-25.1	4000	4200	4400	252	9 61/64	1.30	2.86	26	1 1/32	6.35	1/4	0.40	14.0	17J42
UA70SMC	8-10	5/16-3/8	20.0-35.0	14.8-25.9	25.0-40.0	18.5-29.6	30.0-50.0	22.2-37.0	5000	5300	5700	265	10 7/16	1.39	3.05	26	1 1/32	9.5	3/8	0.45	15.8	17H52

Air Inlet size : NPT1/4" Air Hose size : 10mm×6.5mm×5m for UA40SMC~50SMC 12mm×8.0mm×5m for UA60SMC and UA70SMC

*Torque Range is a guideline value. Please make tool selection appropriately in accordance with an actual application.

UXR-MC SERIES

SPECIFICATIONS

Recommended Air Pressure : 0.6MPa (85psi)

Model	Capacity (Nominal Bolt Size)		Torque Range				Free Speed (Approx.) min ⁻¹		Overall Length (about)		Weight less Socket (about)		From Center to Outside (about)		Sq. Drive Shank		Average Air Consumption		Code
			0.5MPa		0.6MPa														
	mm	in	Nm	ft-lbs	Nm	ft-lbs	0.5MPa	0.6MPa	mm	in	kg	lb	mm	in	mm	in	m ³ /min	ft ³ /min	
UXR-1820MC	18	3/4	140-220	102.7-162.0	160-250	117.8-183.7	4400	4600	322	12 43/64	5.50	12.3	42.0	1 21/32	19.0	3/4	0.70	24.7	14852
UXR-2000MC	20	3/4	200-350	147.6-258.2	250-400	184.4-295.1	4600	4800	355	13 31/32	8.00	17.6	47.0	1 21/32	19.0	3/4	0.95	33.6	14862
UXR-2400SMC	24	7/8	300-550	221.3-405.8	350-600	258.2-442.7	3100	3300	457	17 63/64	12.5	27.6	55.0	1 11/64	25.4	1	1.00	35.3	16622

Air Inlet size : NPT3/8" for UXR-1820MC & UXR-2000MC NPT1/2" for UXR-2400SMC

Air Hose size : 12.7mm×5m for UXR-1820MC~UXR-2400SMC

Inside Trigger is available for UXR-2400SMC

*Torque Range is a guideline value. Please make tool selection appropriately in accordance with an actual application.

UAT SERIES [SHUT OFF TYPE]

UAT series with high fastening accuracy are at the top in Pneumatic Tools. Oil-Pulse Wrench with 3 advantages ; High Efficiency, High Accuracy and High Durability.

FEATURES

Reliable Torque Accuracy and Assured Shut-Off

- 1 Check Valve (PAT.) senses with accuracy the small volume of high-pressure oil from the Relief Valve section during operation and shuts the tool off as soon as it has reached the target torque. Torque accuracy improved significantly.
- 2 Reset Spring (PAT.) enables to shut off the tool accurately even when the air pressure is lowered to 0.35MPa. (Low Air Pressure Type)

Improvement in Energy Efficiency and Maintenance Cost Reduction

3 Cross Section of Roller Blade

As a measure of pulsing, Roller Blades (*2) (Driving Blade with Roller Pin) are adopted. They greatly reduce the friction inside the pulse unit during operation and power weight ratio has been improved by 50% or more (*3). Compared with our conventional oil-pulse tools, Roller Blades create less frictional wear of Driving Blade, which will reduce maintenance costs.

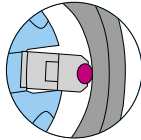

(*2) Roller Blades are adopted to UAT, ULT and UXR series.

(*3) Average value compared with our conventional oil-pulse tools.

4 Cross Section of Sealing

As a measure of sealing, a partition on the anvil and SU-Ring are adopted. The most significant problem of pulse unit is oil sealing because pulsing is repeated dozens of times per second with high pressure. Our study which is gathered over the years helped us to develop URYU's original unique sealing SU-Ring (PAT.). As a result, it extends the maintenance interval by 60% or more (*1).

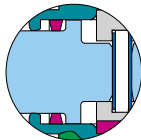

(*1) Compared with our recommended maintenance interval for the conventional oil-pulse tools.

Significant Load Reduction for Operators

- 5 Soft-touch trigger mechanism (PAT.) which can reduce the load for trigger (valve lever) and the compact handgrip greatly reduce the burden for operator's arms, hands and fingers during repeated fastening.

In Consideration of Environment Aspect

- 6 Taking the environment into consideration, the tool's body is unpainted. Body Jacket (*) and Handle Cover are supplied as standard equipment to protect the work.

*Body Jacket is made of oil-proof rubber.

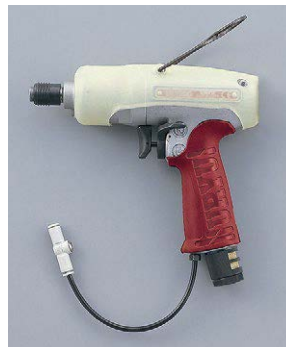
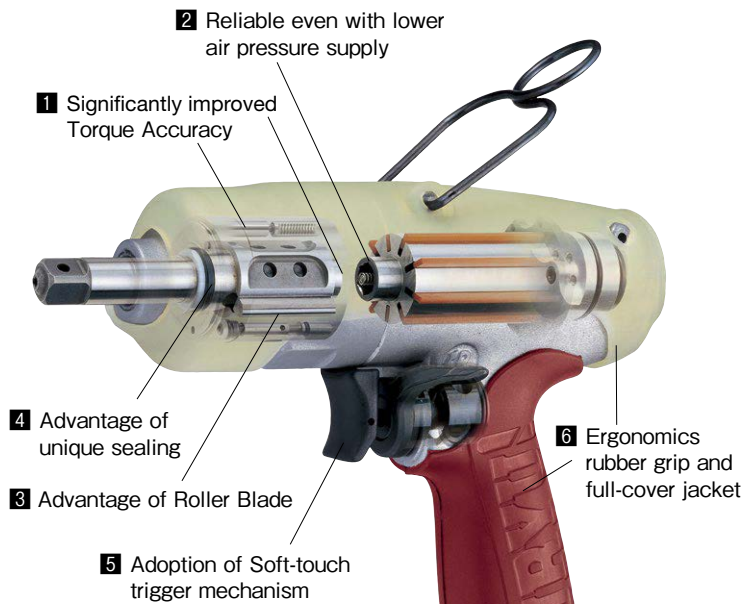

TM type (Fastening Check)
With UTM-1500 Fastening Counter with Poka-Yoke (sold separately), fastening number and time control can be monitored.



To use our product properly

UAT series automatically shut off by detecting inner pressure which is proportionate to fastening torque. The inner pressure is decided by the inertia of rotating section (motor, pulse unit and socket) and working condition. Small models are especially affected by the inner pressure. Please pay careful attention to the selection of model, socket size and air pressure using. Please contact your nearest URYU distributor if it is difficult to determine the usage condition.

2 types are available for different air pressure level.
They can be distinguished by colors.

Standard Type (0.5-0.6MPa)

Low Air Pressure Type (0.4-0.5MPa)



Pistol Type Straight Type Pistol Type Straight Type

*Recommended Air Pressure for UAT30 and UAT40 series is 0.4-0.6MPa.

Quick-change driver anvil type

On pulling the sleeve, insert or take off the bit.

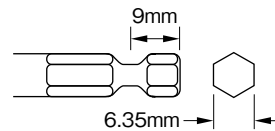

The model name suffixing (D) is the Quick-change driver anvil type.

SPECIFICATIONS

Recommended Air Pressure : 0.4MPa (57psi) - 0.6MPa (85psi)

Model	Capacity (Nominal Bolt Size)		Torque Range				Free Speed (Approx.) min ⁻¹			Overall Length less Socket or Bit (about)		Weight less Socket or Bit (about)		From Center to Outside (about)		Sq. Drive or Hex. Size		Average Air Consumption		Code
			0.4~0.5MPa		0.5~0.6MPa															
	mm	in	Nm	ft-lbs	Nm	ft-lbs	0.4MPa	0.5MPa	0.6MPa	mm	in	kg	lb	mm	in	mm	in	m ³ /min	ft ³ /min	
UAT30D	4-5	No.8-No.10	2.5-5.5	1.85-4.07	2.5-5.5	1.85-4.07	3600	3800	4200	165	6 1/2	0.88	1.94	23.5	15/16	6.35	1/4	0.30	10.5	18A02
UAT40	5	No.10	4.5-8.0	3.3-5.9	4.5-8.0	3.3-5.9	3300	3600	3800	162	6 3/8	0.92	2.0	24.5	31/32	9.5	3/8	0.25	8.8	18A42
UAT40D	5	No.10	4.5-8.0	3.3-5.9	4.5-8.0	3.3-5.9	3300	3600	3800	165	6 1/2	0.92	2.0	24.5	31/32	6.35	1/4	0.25	8.8	18A62
UAT50	6-8	1/4-5/16	-	-	7.0-15.5	5.2-11.5	-	4400	4600	162	6 3/8	0.92	2.0	24.5	31/32	9.5	3/8	0.30	10.5	18B22
UAT50D	6-8	1/4-5/16	-	-	7.0-15.5	5.2-11.5	-	4400	4600	165	6 1/2	0.92	2.0	24.5	31/32	6.35	1/4	0.30	10.5	18B52
UAT60	8	5/16	-	-	15.0-32.0	11.1-23.7	-	6300	6700	174	6 27/32	0.95	2.1	24.5	31/32	9.5	3/8	0.35	12.3	18C82
UAT60D	8	5/16	-	-	15.0-32.0	11.1-23.7	-	6300	6700	177	6 31/32	0.95	2.1	24.5	31/32	6.35	1/4	0.35	12.3	18D12
UAT70	8-10	5/16-3/8	-	-	30.0-55.0	22.2-40.7	-	5700	6000	180	7 3/32	1.05	2.3	25.5	1	9.5	3/8	0.40	14.0	18E32
UAT80	10-12	3/8-1/2	-	-	45.0-63.0	33.3-46.6	-	5300	5600	186	7 5/16	1.25	2.8	28.0	1 3/32	9.5	3/8	0.48	16.8	18F22
UAT90	10-12	3/8-1/2	-	-	50.0-85.0	37.0-62.9	-	5400	5700	192	7 9/16	1.45	3.2	29.0	1 5/32	12.7	1/2	0.53	18.6	18F52
UAT100	12-14	1/2-9/16	-	-	70.0-130.0	51.8-96.2	-	5500	5800	199	7 27/32	1.70	3.7	31.5	1 1/4	12.7	1/2	0.55	19.3	18F82
UAT130	14	9/16	-	-	110-150	81.4-111	-	4300	4500	217	8 35/64	2.30	5.06	34.0	1 11/32	12.7	1/2	0.70	24.6	18G12
UAT150	16	5/8	-	-	140-210	103.6-155.4	-	3800	3900	240	9 29/64	2.90	6.4	38.0	1 1/2	19.0	3/4	0.70	24.6	18G42
UAT180	16-18	5/8-3/4	-	-	160-250	118.4-185.0	-	3100	3300	264	10 25/64	4.00	8.8	52.0	2 3/64	19.0	3/4	1.00	24.6	18G72
UAT200	18-20	3/4	-	-	200-400	148-296	-	2300	2400	281	11 1/16	6.30	13.8	49.5	1 31/32	19.0	3/4	1.00	35.2	18H32
UAT50L	6-8	1/4-5/16	7.0-15.5	5.2-11.5	-	-	4000	4300	-	162	6 3/8	0.92	2.0	24.5	31/32	9.5	3/8	0.25	8.8	18C12
UAT50DL	6-8	1/4-5/16	7.0-15.5	5.2-11.5	-	-	4000	4300	-	165	6 1/2	0.92	2.0	24.5	31/32	6.35	1/4	0.25	8.8	18B72
UAT60L	8	5/16	13.0-28.0	9.6-20.7	-	-	6000	6500	-	174	6 27/32	0.95	2.1	24.5	31/32	9.5	3/8	0.25	8.8	18D72
UAT60DL	8	5/16	13.0-28.0	9.6-20.7	-	-	6000	6500	-	177	6 31/32	0.95	2.1	24.5	31/32	6.35	1/4	0.25	8.8	18D32
UAT70L	8-10	5/16-3/8	25.0-48.0	18.5-35.5	-	-	5300	5600	-	180	7 3/32	1.05	2.3	25.5	1	9.5	3/8	0.30	10.5	18E82
UAT80L	10-12	3/8-1/2	35.0-55.0	25.9-40.7	-	-	5000	5300	-	186	7 5/16	1.25	2.8	28.0	1 3/32	9.5	3/8	0.40	14.0	18F32
UAT90L	10-12	3/8-1/2	45.0-75.0	33.3-55.5	-	-	5100	5600	-	192	7 9/16	1.45	3.2	29.0	1 5/32	12.7	1/2	0.45	15.8	18F62
UAT100L	12	1/2	60.0-110.0	44.4-81.4	-	-	5500	5800	-	199	7 27/32	1.70	3.7	31.5	1 1/4	12.7	1/2	0.48	16.8	18F92
UAT130L	12-14	1/2-9/16	80.0-125.0	59.2-92.5	-	-	4300	4500	-	217	8 35/64	2.30	5.06	34.0	1 11/32	12.7	1/2	0.50	17.6	18G22
UAT150L	14-16	9/16-5/8	110.0-170.0	81.4-125.8	-	-	3700	3800	-	240	9 29/64	2.90	6.4	38.0	1 1/2	19.0	3/4	0.50	17.6	18G52
UAT180L	16	5/8	130.0-210.0	96.2-155.4	-	-	3000	3100	-	264	10 25/64	4.00	8.8	52.0	2 3/64	19.0	3/4	1.00	17.6	18G82
UAT200L	16-18	5/8-3/4	170.0-280.0	125.8-207.2	-	-	2200	2300	-	281	11 1/16	6.30	13.8	49.5	1 31/32	19.0	3/4	0.70	24.6	18H42

Air Inlet Thread : NPT 1/4" for UAT30D-UAT150(L)

Air Hose Size : 10mmx6.5mmx5m for UAT30D - UAT50

12mmx8.0mmx5m for UAT60 - UAT100

NPT 3/8" for UAT180(L)

16mmx11.0mmx5m for UAT100L - UAT180(L)

21mmx12.7mmx5m for UAT200(L)

*Torque Range is a guideline value. Please make tool selection appropriately in accordance with an actual application.

SPECIFICATIONS

Recommended Air Pressure : 0.4MPa (57psi) - 0.6MPa (85psi)

Model	Capacity (Nominal Bolt Size)		Torque Range				Free Speed (Approx.) min ⁻¹			Overall Length less Socket or Bit (about)		Weight less Socket or Bit (about)		From Center to Outside (about)		Sq. Drive or Hex. Size		Average Air Consumption		Code
			0.4~0.5MPa		0.5~0.6MPa															
	mm	in	Nm	ft-lbs	Nm	ft-lbs	0.4MPa	0.5MPa	0.6MPa	mm	in	kg	lb	mm	in	mm	in	m ³ /min	ft ³ /min	
UAT30SD	4-5	No.8-No.10	2.5-5.5	1.85-4.07	2.5-5.5	1.85-4.07	3100	3300	3400	222	8 47/64	0.75	1.94	21.5	27/32	6.35	1/4	0.35	12.3	18H12
UAT40S	5	No.10	4.5-8.0	3.3-5.9	4.5-8.0	3.3-5.9	3000	3200	3300	224	8 13/16	0.85	1.9	22.5	7/8	9.5	3/8	0.20	7.0	18A92
UAT40SD	5	No.10	4.5-8.0	3.3-5.9	4.5-8.0	3.3-5.9	3000	3200	3300	227	8 15/16	0.85	1.9	22.5	7/8	6.35	1/4	0.20	7.0	18B02
UAT50S	6-8	1/4-5/16	-	-	7.0-15.5	5.2-11.5	-	3700	3900	224	8 13/16	0.85	1.9	22.5	7/8	9.5	3/8	0.25	8.8	18C22
UAT50SD	6-8	1/4-5/16	-	-	7.0-15.5	5.2-11.5	-	3700	3900	227	8 15/16	0.85	1.9	22.5	7/8	6.35	1/4	0.25	8.8	18C32
UAT60S	8	5/16	-	-	15.0-32.0	11.1-23.7	-	5400	5700	229	9	0.87	1.9	22.5	7/8	9.5	3/8	0.30	10.5	18D82
UAT60SD	8	5/16	-	-	15.0-32.0	11.1-23.7	-	5400	5700	232	9 1/8	0.87	1.9	22.5	7/8	6.35	1/4	0.30	10.5	18D92
UAT70S	8-10	5/16-3/8	-	-	30.0-50.0	22.2-37.0	-	4400	4700	239	9 13/32	0.95	2.1	23.5	7/8	9.5	3/8	0.35	12.3	18E92
UAT50SL	6-8	1/4-5/16	7.0-15.5	5.2-11.5	-	-	3800	4000	-	224	8 13/16	0.85	1.9	22.5	7/8	9.5	3/8	0.20	7.0	18C52
UAT50SDL	6-8	1/4-5/16	7.0-15.5	5.2-11.5	-	-	3800	4000	-	227	8 15/16	0.85	1.9	22.5	7/8	6.35	1/4	0.20	7.0	18C42
UAT60SL	8	5/16	13.0-28.0	9.6-20.7	-	-	5300	5600	-	229	9	0.87	1.9	22.5	7/8	9.5	3/8	0.25	8.8	18E12
UAT60SDL	8	5/16	13.0-28.0	9.6-20.7	-	-	5300	5600	-	232	9 1/8	0.87	1.9	22.5	7/8	6.35	1/4	0.25	8.8	18E02
UAT70SL	8-10	5/16-3/8	25.0-45.0	18.5-33.3	-	-	4400	4700	-	239	9 13/32	0.95	2.1	23.5	7/8	9.5	3/8	0.27	9.5	18F02

Air Inlet Thread : NPT 1/4"

Air Hose Size : 10mmx6.5mmx5m for UAT30SD - UAT50S

12mmx8.0mmx5m for UAT60S - UAT70S

*Torque Range is a guideline value. Please make tool selection appropriately in accordance with an actual application.

UXR-T SERIES

SPECIFICATIONS

Recommended Air Pressure:0.6MPa(85psi)

Model	Capacity (Nominal Bolt Size)		Torque Range		Free Speed (about) min ⁻¹		Overall Length less Socket (about)		Weight less Socket (about)		From Center to Outside (about)		Sq. Drive Shank		Average Air Consumption		Code
	mm	in	Nm	ft-lbs	0.5MPa	0.6MPa	mm	in	kg	lb	mm	in	mm	in	m ³ /min	ft ³ /min	
UXR-T2400S	24	7/8	360-650	260-470	3400	3600	444	17 31/64	12.00	26.46	61.5	2 27/64	25.4	1	1.00	35.3	16522
UXR-T3000S	30	1 1/8	450-850	330-620	4200	4400	477	18 25/32	14.50	31.97	62.0	2 7/16	25.4	1	1.05	37.1	17022

Air Inlet Thread : NPT1/2" Air Hose Size : 12.7mmx5m Inside Trigger is available

*Torque Range is a guideline value. Please make tool selection appropriately in accordance with an actual application.

UL SERIES [NON SHUT-OFF TYPE]

Ultralight Oil-Pulse Tool. Reduce the burden on the operators.

BOLT & NUT SETTERS



Quick-change driver anvil type

On pulling the sleeve, insert or take off the bit.



The model name suffixing (D) is the Quick-change driver anvil type.

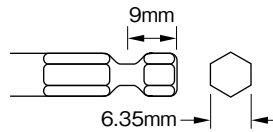

SPECIFICATIONS

Recommended Air Pressure : 0.5MPa (72psi) - 0.6MPa (85psi)

Model	Capacity (Nominal Bolt Size)		Torque Range				Free Speed (Approx.) min ⁻¹		Overall Length Less Socket or Bit (Approx.)		Weight less Socket or Bit (Approx.)		From Center to Outside (Approx.)		Sq. Drive or Hex. Size		Average Air Consumption		Code
			0.5MPa		0.6MPa														
	mm	in	Nm	ft-lbs	Nm	ft-lbs	0.5MPa	0.6MPa	mm	in	kg	lb	mm	in	mm	in	m ³ /min	ft ³ /min	
UL30	5	No.10	5.5-10.5	4.1-7.8	6-12	4.4-8.9	5400	5700	133	5 15/64	0.70	1.5	20.5	13/16	9.5	3/8	0.20	7.0	14282
UL30D	5	No.10	5.5-10.5	4.1-7.8	6-12	4.4-8.9	5400	5700	137	5 25/64	0.70	1.5	20.5	13/16	6.35	1/4	0.20	7.0	14292
UL40	5-6	No.10-1/4	11-20	8.1-14.8	13-22	9.6-16.3	5800	6100	133	5 15/64	0.70	1.5	20.5	13/16	9.5	3/8	0.20	7.0	14302
UL40D	5-6	No.10-1/4	9-17	6.7-12.6	11-20	8.1-14.8	5800	6100	137	5 25/64	0.70	1.5	20.5	13/16	6.35	1/4	0.20	7.0	14322
UL50	6-8	1/4-5/16	20-32	14.8-23.7	22-35	16.3-25.9	6100	6400	140	5 33/64	0.77	1.7	22.0	55/64	9.5	3/8	0.30	10.5	14332
UL50D	6-8	1/4-5/16	16-25	11.8-18.5	18-28	13.3-20.7	6100	6400	146	5 3/4	0.77	1.7	22.0	55/64	6.35	1/4	0.30	10.5	14352
UL60	8	5/16	30-45	22.2-33.3	32-50	23.7-37.0	6700	7000	140	5 33/64	0.82	1.8	22.0	55/64	9.5	3/8	0.40	14.0	14362
UL60D	8	5/16	20-32	14.8-23.7	22-35	16.3-25.9	6700	7000	143	5 5/8	0.82	1.8	22.0	55/64	6.35	1/4	0.40	14.0	14372
UL70	8-10	5/16-3/8	36-60	26.6-44.4	40-65	29.6-48.1	5400	5700	153	6 1/32	0.95	2.1	23.0	29/32	9.5	3/8	0.45	15.8	14382
* UL80	10-12	3/8-1/2	40-55	29.6-40.7	45-70	33.3-50.0	5600	5900	162	6 3/8	1.15	2.5	26.0	1 1/32	9.5	3/8	0.48	16.8	11722
UL90	10-12	3/8-1/2	55-90	40.7-66.6	60-100	44.4-74.0	5700	6000	170	6 11/16	1.30	2.9	27.0	1 1/16	12.7	1/2	0.53	18.6	14392
UL100	12-14	1/2	72-120	53.3-88.8	80-130	59.2-96.2	5100	5400	177	6 31/32	1.66	3.7	29.5	1 5/32	12.7	1/2	0.58	20.3	15502
UL130	14	9/16	90-145	66.6-107.3	100-160	74.0-118.4	4200	4400	197	7 3/4	2.30	5.1	32.0	1 17/64	12.7	1/2	0.65	22.7	14102
UL150	16	5/8	135-210	99.6-154.7	150-230	109.9-169.6	3500	3800	213	8 25/64	3.00	6.6	36.0	1 27/64	19.0	3/4	0.70	24.7	11482
UL30S	5	No.10	5.5-10.5	4.1-7.8	6-12	4.4-8.9	4700	5000	205	8 5/64	0.62	1.4	20.5	51/64	9.5	3/8	0.23	8.1	10622
UL30SD	5	No.10	5.5-10.5	4.1-7.8	6-12	4.4-8.9	4700	5000	209	8 15/64	0.62	1.4	20.5	51/64	6.35	1/4	0.23	8.1	10632
UL40S	5-6	No.10-1/4	11-20	8.1-14.8	11-22	8.1-16.3	4700	5000	205	8 5/64	0.62	1.4	20.5	51/64	9.5	3/8	0.23	8.1	10652
UL40SD	5-6	No.10-1/4	9-17	6.7-12.6	9-20	6.7-14.8	4700	5000	209	8 15/64	0.62	1.4	20.5	51/64	6.35	1/4	0.23	8.1	10662
UL50S	6-8	1/4-5/16	20-32	14.8-23.7	22-35	16.3-25.9	6100	6400	208	8 3/16	0.74	1.6	22.0	7/8	9.5	3/8	0.35	12.3	10682
UL50SD	6-8	1/4-5/16	16-25	11.8-18.5	18-28	13.3-20.7	6100	6400	214	8 27/64	0.74	1.6	22.0	7/8	6.35	1/4	0.35	12.3	10692
UL60S	8	5/16	30-45	22.2-33.3	32-50	23.7-37.0	6400	6700	209	8 15/64	0.77	1.7	22.0	7/8	9.5	3/8	0.45	15.8	10722
UL60SD	8	5/16	20-32	14.8-23.7	22-35	16.3-25.9	6400	6700	212	8 11/32	0.77	1.7	22.0	7/8	6.35	1/4	0.45	15.8	10732
UL70S	8-10	5/16-3/8	36-60	26.6-44.4	36-60	26.6-44.4	5100	5400	223	8 25/32	0.87	1.9	23.5	59/64	9.5	3/8	0.40	14	10752

Air Inlet Size : NPT1/4"

Air Hose Size : 10mm×6.5mm×5m for UL30-50 12mm×8.0mm×5m for UL60-150

Air Hose Size : 10mm×6.5mm×5m for UL30S-50S 12mm×8.0mm×5m for UL60S-70S

*Please refrain from using UL80 at around max. torque as it is developed to aim at torque output between UL70 & UL90.

*Torque Range is a guideline value. Please make tool selection appropriately in accordance with an actual application.

CORNER TYPE ULT SERIES

ULT SERIES [SHUT OFF TYPE]

Easy to operate in narrow area.
Reliable fastening with oil-pulse wrench.



ULT50C



ULT70CH

2 types are available for different air pressure level.
They can be distinguished by colors.



Standard Type
(0.5~0.6MPa)



Low Air Pressure Type
(0.4~0.5MPa)

★To do torque adjustment...

Remove the Hammer Casing Nut and confirm you see the Relief Valve Spindle through the hole. Use Allen Wrench (1.5mm) to adjust torque. Turn the Relief Valve Spindle clockwise to increase tightening torque and anti-clockwise to decrease tightening torque. Fix the Hammer Casing Nut firmly after adjustment.

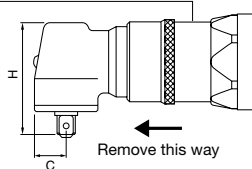

Head Sizes

Model	H		C		Model	H		C	
	mm	in	mm	in		mm	in	mm	in
ULT40C	59	2 21/64	16	5/8	ULT70C	70	2 3/4	18	45/64
ULT50C	59	2 21/64	16	5/8	ULT70CH	77	3 1/32	22	7/8
ULT60C	59	2 21/64	16	5/8					

SPECIFICATIONS

Recommended Air Pressure : 0.4MPa (57psi) - 0.6MPa (85psi)

Model	Capacity (Nominal Bolt Size)		Torque Range				Free Speed (Approx.) min ⁻¹		Overall Length less Socket (about)		Weight less Socket (about)		From Center to Outside (about)		Sq. Drive Shank		Average Air Consumption		Code
			0.4~0.5MPa		0.5~0.6MPa		0.4MPa	0.6MPa											
	mm	in	Nm	ft-lbs	Nm	ft-lbs	mm	in	kg	lb	mm	in	mm	in	m ³ /min	ft ³ /min			
ULT40C	5	No.10	-	-	4.5-7.5	3.33-5.55	3300	3500	250	9 27/32	1.30	2.9	24.5	31/32	9.5	3/8	0.20	7.0	12692
ULT50C	6-8	1/4-5/16	-	-	7.0-15.5	5.2-11.5	-	4500	250	9 27/32	1.35	3.0	24.5	31/32	9.5	3/8	0.25	8.6	12732
ULT60C	8	5/16	-	-	13-28	9.6-20.7	-	5200	261	10 9/32	1.45	3.2	24.5	31/32	9.5	3/8	0.30	10.5	12752
ULT70C	8	5/16	-	-	20-35	14.8-25.9	-	4400	275	10 53/64	1.65	3.6	26.5	1 3/64	9.5	3/8	0.35	12.3	12772
ULT70CH	8-10	5/16-3/8	-	-	30-50	22.2-37.0	-	2500	290	11 27/64	1.85	4.1	26.5	1 3/64	12.7	1/2	0.35	12.3	11292
ULT50CL	6-8	1/4-5/16	7.0-15.5	5.2-11.5	-	-	4500	-	250	9 27/32	1.35	3.0	24.5	31/32	9.5	3/8	0.20	7.0	12742
ULT60CL	8	5/16	13-28	9.6-20.7	-	-	5200	-	261	10 9/32	1.45	3.2	24.5	31/32	9.5	3/8	0.25	8.6	12762
ULT70CL	8	5/16	20-35	14.8-25.9	-	-	4300	-	275	10 53/64	1.65	3.6	26.5	1 3/64	9.5	3/8	0.27	9.5	12782
ULT70CHL	8-10	5/16-3/8	30-50	22.2-37.0	-	-	2300	-	290	11 27/64	1.85	4.1	26.5	1 3/64	12.7	1/2	0.27	9.5	11302

Air Inlet Size : NPT 1/4"

Air Hose Size : 10mm×6.5mm×5m for ULT40C~50C(L) 12mm×8.0mm×5m for ULT60C~70C(L) , and 70CH(L)

*Torque Range is a guideline value. Please make tool selection appropriately in accordance with an actual application.

U / UXR SERIES [NON SHUT-OFF TYPE]

Our long-selling tools proud reliability and achievements.



U-310SD

Quick-change driver anvil type

On pulling the sleeve, insert or take off the bit.



The model name suffixing (D) is the Quick-change driver anvil type.

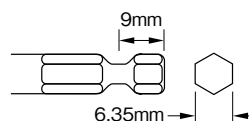

SPECIFICATIONS

Recommended Air Pressure : 0.6MPa (85psi)

Model	Capacity (Nominal Bolt Size)		Torque Range				Free Speed (Approx.) min ⁻¹		Overall Length (about)		Weight less Socket or Bit (about)		From Center to Outside (about)		Sq. Drive or Hex. Size		Average Air Consumption		Code
			0.5MPa		0.6MPa		0.5MPa	0.6MPa											
	mm	in	Nm	ft-lbs	Nm	ft-lbs	0.5MPa	0.6MPa	mm	in	kg	lb	mm	in	mm	in	m ³ /min	ft ³ /min	
U-310SD	3-4	No.5-No.8	2.1-2.6	1.6-1.9	2.5-3.1	1.8-2.2	10000	11000	222	8 47/64	0.62	1.5	18.0	47/64	6.35	1/4	0.15	5.3	19662
U-350SD	3-4	No.5-No.8	3.0-5.0	2.2-3.7	3.5-5.8	2.5-4.2	10000	10500	238	9 3/8	0.71	1.5	22.0	47/64	6.35	1/4	0.15	5.3	19332
U-350D	3-4	No.5-No.8	3.0-5.0	2.2-3.7	3.5-5.8	2.5-4.2	10000	10500	154	6 1/16	0.77	1.7	22.0	7/8	6.35	1/4	0.15	5.3	19242
UXR-2000	18-20	3/4	255-385	188.2-284.1	300-450	220-330	4000	4200	282	11 7/64	6.50	14.3	47.0	1 27/32	19.0	3/4	0.90	31.5	17602

Air Inlet Thread : NPT1/4" for U-350D
NPT3/8" for UXR-2000

Air Hose Size : 6.35mm (1/4") for U-350D
12.7mm (1/2") for UXR-2000

*Torque Range is a guideline value. Please make tool selection appropriately in accordance with an actual application.

SPECIFICATIONS

Recommended Air Pressure : 0.6MPa (85psi)

Model	Capacity (Nominal Bolt Size)		Torque Range				Free Speed (Approx.) min ⁻¹		Overall Length (about)		Weight less Socket (about)		From Center to Outside (about)		Sq. Drive Shank		Average Air Consumption		Code
			0.5MPa		0.6MPa		0.5MPa	0.6MPa											
	mm	in	Nm	ft-lbs	Nm	ft-lbs	0.5MPa	0.6MPa	mm	in	kg	lb	mm	in	mm	in	m ³ /min	ft ³ /min	
UXR-2000S	18-20	3/4	255-385	188-284	300-450	220-330	4000	4200	340	13 25/64	7.00	15.4	47.0	1 27/32	19.0	3/4	0.90	31.6	17632
UXR-2400S	24	7/8	340-550	251-406	400-650	290-470	3700	4000	385	15 5/32	11.00	23.7	55.0	2 1/8	25.4	1	1.00	35.2	17692
UXR-3000S	30	1 1/4	425-725	313-535	500-850	360-630	4200	4400	455	17 29/32	13.30	29.3	62.0	2 1/8	25.4	1	1.05	37.1	17532

Air Inlet Size : NPT3/8" for UXR-2000S
NPT1/2" for UXR-2400S & UXR-3000S

Inside Trigger is available for UXR-2000S~UXR-3000S
Air Hose Size : 12.7mm (1/2") for UXR-2000S~UXR-3000S

*Torque Range is a guideline value. Please make tool selection appropriately in accordance with an actual application.

CUSTOM-MADE MODELS

These Models are specially designed for user's request.



RATCHET WRENCHES



URW-8



URW-6



URW-12N



URW-8N



URW-12NB



URW-10N

FEATURES

Most suitable for fastening in narrow application. Bent head type, Thinner head type and Extended head type are also available for hard-to-reach access fastening jobs.

Reverse rotation is obtained by simply turning a tool over.

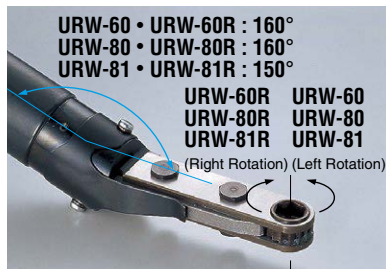

Head Sizes

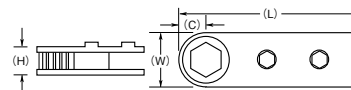

Model	H		W		L		C	
	mm	in	mm	in	mm	in	mm	in
URW-6,60,60R	13.0	33/64	20.0	25/32	88.0	3 15/32	10.0	25/64
URW-8,8N,9N,80,80R,81,81R	18.0	45/64	25.0	63/64	102.5	4 1/32	12.5	31/64
URW-10N	18.0	45/64	33.0	1 19/64	106.5	4 3/16	16.5	21/32
URW-12N	18.0	45/64	36.0	1 27/64	109.5	4 5/16	18.0	45/64
URW-12NA	18.0	45/64	46.0	1 13/16	120.5	4 3/4	23.0	29/32
URW-12NB	18.0	45/64	54.0	2 1/8	128.5	5 1/16	27.0	1 1/16

SPECIFICATIONS

Recommended Air Pressure : 0.4MPa (57psi)

Model	Capacity (Nominal Bolt Size)		Max. Torque		Free Speed (about)	Overall Length (about)		Weight (about)		Hex. Size of Ratchet		Average Air Consumption		Code	
	mm	in	Nm	ft-lbs		mm	in	kg	lb	mm		m ³ /min			
					min ⁻¹					in		ft ³ /min			
URW-6	6	1/4	11	8.1	210	292	11 1/2	1.15	2.53	6, 7, 8, ⑩, 11, 12	1/4, 5/16, 3/8, 7/16		0.28	9.9	20052
URW-60	6	1/4	11	8.1	210	288	11 11/32	1.15	2.53	6, 7, 8, ⑩, 11, 12	1/4, 5/16, 3/8, 7/16		0.28	9.9	20082
URW-60R	6	1/4	11	8.1	210	288	11 11/32	1.15	2.53	6, 7, 8, ⑩, 11, 12	1/4, 5/16, 3/8, 7/16		0.28	9.9	20092
URW-8N	8	5/16	16	11.8	260	300	11 13/16	2.25	4.95	7, 8, 9, 10, 11, 12, 13, ⑭, 15	7/16, 1/2, 9/16		0.55	19.5	21212
URW-80	8	5/16	16	11.8	240	300	11 13/16	2.25	4.95	7, 8, 9, 10, 11, 12, 13, ⑭, 15	7/16, 1/2, 9/16		0.55	19.5	22912
URW-80R	8	5/16	16	11.8	240	300	11 13/16	2.25	4.95	7, 8, 9, 10, 11, 12, 13, ⑭, 15	7/16, 1/2, 9/16		0.55	19.5	22962
URW-81	8	5/16	16	11.8	240	300	11 13/16	2.25	4.95	7, 8, 9, 10, 11, 12, 13, ⑭, 15	7/16, 1/2, 9/16		0.55	19.5	23112
URW-81R	8	5/16	16	11.8	240	300	11 13/16	2.25	4.95	7, 8, 9, 10, 11, 12, 13, ⑭, 15	7/16, 1/2, 9/16		0.55	19.5	23162
URW-8	8	5/16	16	11.8	240	360	14 3/16	1.90	4.18	7, 8, 9, 10, 11, 12, 13, ⑭, 15	7/16, 1/2, 9/16		0.56	19.8	20152
URW-9N	10	3/8	31	22.9	140	380	15	2.35	5.17	7, 8, 9, 10, 11, 12, 13, ⑭, 15	7/16, 1/2, 9/16		0.67	23.7	22742
URW-10N	10	3/8	57	42.2	155	394	15 33/64	2.65	5.83	10, 12, 13, 14, 15, 16, ⑰, 18, 19	9/16, 5/8, 11/16, 3/4		0.70	25.0	21412
URW-12N	12	1/2	59	43.7	145	397	15 5/8	2.70	5.94	12, 14, 16, 17, 18, 19, ⑳, 21, 22, 23	3/8, 1/2, 9/16, 5/8, 11/16, 3/4, 13/16		0.70	25.0	21512
URW-12NA	12	1/2	78	57.7	105	408	16 1/16	2.80	6.16	17, 18, 19, 21, 22, 23, ㉑, 26, 27	11/16, 3/4, 15/16		0.70	25.0	21612
URW-12NB	12	1/2	93	68.8	90	416	16 19/64	2.90	6.38	24, 29, ㉒, 32	5/8, 11/16, 3/4, 13/16, 7/8, 15/16, 1, 1-1/8		0.70	25.0	21812

Air Inlet Thread (Pipe Tap) : NPT1/4"

Air Hose Size (Inside Diameter) : 9.5mm (3/8")

Code mentioned in the above list comes with the standard Hex size of ratchet circled ○. Specify Hex. size when ordering.

Max Torque is a guideline at 0.6MPa.

OPEN-END WRENCHES / GEARED WRENCHES



UOW-11-14



UOW-11-10



UOW-11-22



UOW-11-30



UOW-T60-22



UGW-8N

Safety Start Lever

Safety Start Lever is installed as standard equipment for UOW series to prevent accidental start of tool.

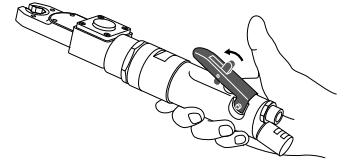

Push down the self-locking lever to operate tool as above.

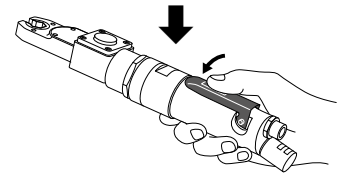

FEATURES

(OPEN-END WRENCHES)

URYU offers two types of Open-End Wrenches for fast, accurate tube nut tightening. **UOW-11 series** is a stall torque type and **UOW-T60 series** is a mechanical shut-off type with external torque adjustment.

(GEARED WRENCHES)

Gear drive mechanism amplifies and transmits the motor rotation power. **UGW** Geared Wrench offers quiet operation with good durability.

EXTERNAL DIAL

Torque adjustment. (No special tool is needed)



1 : Min.
3 : Max.

UOW-T60 series only.

Head Sizes	Model	H		W		O		C	
		mm	in	mm	in	mm	in	mm	in
	UOW-11-10,UOW-T60-10	14.0	35/64	37.0	1 29/64	5.0~6.0	13/64~15/64	10.0	25/64
	UOW-11-14,UOW-T60-14	14.0	35/64	40.0	1 37/64	6.0~9.0	15/64~23/64	13.0	33/64
	UOW-11-22,UOW-T60-22	16.0	5/8	56.0	2 13/64	13.0~15.0	33/64~19/32	17.0	43/64
	UOW-11-30,UOW-T60-30	16.0	5/8	68.0	2 43/64	15.0~23.0	19/32~29/32	21.0	53/64
	UGW-6N	14.0	35/64	32.0	1 17/64	-	-	12.9	33/64
	UGW-8N	14.0	35/64	36.0	1 27/64	-	-	15.8	39/64

SPECIFICATIONS

Recommended Air Pressure : 0.6MPa (85psi)

Model	Max. Torque / Range		Free Speed (about)	Overall Length (about)		Weight (about)		Hex. Size of Gear Socket		Average Air Consumption		Code
	Nm	ft-lbs		mm	in	kg	lb	mm		in		
UOW-11-10	13	9.6	390	295	11 47/64	1.50	3.31	7, 8, 9, ⑩, 11, 12		0.30	10.5	23502
UOW-11-14	16	11.8	290	311	12 1/4	1.60	3.52	10, 11, 12, 13, ⑭, 15, 16, 17		0.30	10.5	23542
UOW-11-22	24	17.8	220	326	12 53/64	1.75	3.85	11, 12, 13, 14, 15, 16, 17, 18, 19, 20, 21, ⑳, 24		0.30	10.5	23602
UOW-11-30	32	23.7	160	347	13 21/32	2.00	4.40	14, 17, 18, 19, 23, 24, 26, 27, 29, ⑳, 32		0.30	10.5	23662
UOW-T60-10	4-14	3.0-10.4	300	370	14 5/8	2.10	4.62	7, 8, 9, ⑩, 11, 12		0.30	10.5	24202
UOW-T60-14	5-17	3.7-12.6	240	385	15 1/8	2.20	4.85	10, 11, 12, 13, ⑭, 15, 16, 17		0.30	10.5	24222
UOW-T60-22	7-24	5.2-17.8	170	400	15 3/4	2.35	5.18	11, 12, 13, 14, 15, 16, 17, 18, 19, 20, 21, ⑳, 24		0.30	10.5	24242
UOW-T60-30	10-32	7.4-23.7	130	420	16 5/8	2.60	5.73	14, 17, 18, 19, 23, 24, 26, 27, 29, ⑳, 32		0.30	10.5	24262
UGW-6N	18	13.3	530	310	12 13/64	1.40	3.08	9, ⑩, 11, 12		0.30	10.5	24602
UGW-8N	23	17.0	410	322	12 11/16	1.45	3.19	10, 12, 13, ⑭, 17		0.30	10.5	24652

Air Inlet Thread (Pipe Tap) : NPT1/4" Air Hose Size (Inside Diameter) : 9.5mm (3/8")

Code mentioned in the above list comes with the standard Hex size of gear socket circled ○. Specify Hex. size when ordering.

ANGLE NUTRUNNERS

Instant automatic shut-off providing reduced reaction.
Low inertia design providing increased accuracy.



UAN-611RM TORQUE MONITORING TYPE



UAN-611R-30C

FEATURES

- Simple and accurate method to adjust torque output by Phillips Driver permitting quick setup.
- Designed with a spline type interface allowing multiple head positions for the most comfortable throttle location on those hard to reach applications.
- The pneumatic motor is designed to offer high power performance by reducing motor inertia to the minimum level.
- Ergonomically designed Protector offers firm gripping for ergonomic fastening.

Head Sizes	Model	C		H	
		mm	in	mm	in
	UAN-611R-60C, UAN-611RM-60C	14.0	35/64	47.0	1 27/32
	UAN-611R-50C, UAN-611RM-50C	14.0	35/64	47.0	1 27/32
	UAN-611R-40C, UAN-611RM-40C	14.0	35/64	47.0	1 27/32
	UAN-611R-30C, UAN-611RM-30C	14.0	35/64	47.0	1 27/32
	UAN-701R-60C, UAN-701RM-60C	14.0	35/64	47.0	1 27/32
	UAN-701R-40C, UAN-701RM-40C	18.0	45/64	51.0	2 1/64
	UAN-701R-30C, UAN-701RM-30C	18.0	45/64	58.0	2 9/32

System Layout For Torque Monitoring Type

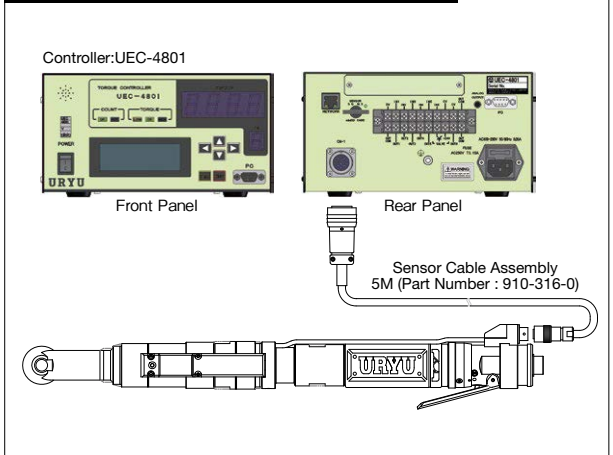

SPECIFICATIONS

Recommended Air Pressure : 0.6MPa (85psi)

Model	Bolt Capacity		Torque Range		Free Speed (about)	Overall Length less Socket (about)		Weight less Socket (about)		From Center to Outside (about)		Angle Height (about)		Square Drive Shank		Average Air Consumption		Code
	mm	in	Nm	ft-lbs		mm	in	kg	lb	mm	in	mm	in	mm	in	m ³ /min	ft ³ /min	
UAN-611RM-60C	6	1/4	6.5-12.0	4.3-8.6	620	419	16 1/2	2.0	4.4	14.0	35/64	47	1 55/64	9.5	3/8	0.6	21.2	26852
UAN-611RM-50C	6-8	1/4-5/16	8.5-15.0	5.7-10.8	470	409	16 7/64	2.0	4.4	14.0	35/64	47	1 55/64	9.5	3/8	0.6	21.2	26842
UAN-611RM-40C	6-8	1/4-5/16	10.0-18.0	7.2-12.9	400	409	16 7/64	2.0	4.4	14.0	35/64	47	1 55/64	9.5	3/8	0.6	21.2	26832
UAN-611RM-30C	8	5/16	13.0-25.0	9.3-18.0	270	409	16 7/64	2.0	4.4	14.0	35/64	47	1 55/64	9.5	3/8	0.6	21.2	26822
UAN-701RM-60C	8	5/16	20.0-31.0	14.5-23.1	600	480	18 57/64	2.7	5.94	14.0	35/64	47	1 55/64	9.5	3/8	0.9	31.8	27032
UAN-701RM-40C	8-10	5/16-3/8	28.0-45.0	21.0-33.3	400	492	19 3/8	2.9	6.38	18.0	45/64	51	2	9.5	3/8	0.9	31.8	27022
UAN-701RM-30C	10-12	3/8-1/2	37.0-60.0	27.5-44.1	300	492	19 3/8	2.9	6.38	18.0	45/64	58	2 9/32	12.7	1/2	0.9	31.8	27012

Air Inlet Thread (Pipe Tap) : NPT1/4" Air Hose Size (Inside Diameter) : 9.5mm (3/8")

*Torque Range is a guideline value. Please make tool selection appropriately in accordance with an actual application.

SPECIFICATIONS

Recommended Air Pressure : 0.6MPa (85psi)

Model	Bolt Capacity		Torque Range		Free Speed (about)	Overall Length (about)		Weight less Socket (about)		From Center to Outside (about)		Angle Height (about)		Square Drive Shank		Average Air Consumption		Code
	mm	in	Nm	ft-lbs		mm	in	kg	lb	mm	in	mm	in	mm	in	m ³ /min	ft ³ /min	
UAN-611R-60C	6	1/4	6.5-12.0	4.3-8.6	620	383	15 5/64	1.6	3.52	14.0	35/64	47	1 55/64	9.5	3/8	0.6	21.2	26892
UAN-611R-50C	6-8	1/4-5/16	8.5-15.0	5.7-10.8	470	373	14 11/16	1.6	3.52	14.0	35/64	47	1 55/64	9.5	3/8	0.6	21.2	26882
UAN-611R-40C	6-8	1/4-5/16	10.0-18.0	7.2-12.9	400	373	14 11/16	1.6	3.52	14.0	35/64	47	1 55/64	9.5	3/8	0.6	21.2	26872
UAN-611R-30C	8	5/16	13.0-25.0	9.3-18.0	270	373	14 11/16	1.6	3.52	14.0	35/64	47	1 55/64	9.5	3/8	0.6	21.2	26862
UAN-701R-60C	8	5/16	20.0-31.0	14.5-23.1	600	445	17 33/64	2.4	5.29	14.0	35/64	47	1 55/64	9.5	3/8	0.9	31.8	26972
UAN-701R-40C	8-10	5/16-3/8	28.0-45.0	21.0-33.3	400	455	17 29/32	2.4	5.29	18.0	45/64	51	2	9.5	3/8	0.9	31.8	26962
UAN-701R-30C	10-12	3/8-1/2	37.0-60.0	27.5-44.1	300	455	17 29/32	2.4	5.29	18.0	45/64	58	2 9/32	12.7	1/2	0.9	31.8	26952

Air Inlet Thread (Pipe Tap) : NPT1/4" Air Hose Size (Inside Diameter) : 9.5mm (3/8") Fastening count is available with UTM-1500, as an option.

*Torque Range is a guideline value. Please make tool selection appropriately in accordance with an actual application.

IMPACT WRENCHES

Optimal Torque of Bolt

The optimal torque of bolt is based on the clamp force achieved. The clamp force applied to bolt should not exceed 70% of the proof load of bolt and the optimal torque applied to bolt should be as much as 60% of the proof load. See the following equation to calculate the optimal torque.

$$T = k \cdot D \cdot N \quad \text{Torque} = \text{Coefficient of friction} \times \text{Nominal Diameter} \times \text{Clamp Force (Tension)}$$

Property Class	4.8		5.8		6.8		8.8		10.9		12.9	
Nominal Diameter	Torque (Nm)	Proof Load (N)	Torque (Nm)	Proof Load (N)	Torque (Nm)	Proof Load (N)	Torque (Nm)	Proof Load (N)	Torque (Nm)	Proof Load (N)	Torque (Nm)	Proof Load (N)
M3	0.6	1560	0.8	1910	0.9	2210	1.2	2920	1.7	4180	2.0	4880
M4	1.4	2720	1.8	3340	2.0	3860	2.7	5100	4.0	7290	4.6	8520
M5	2.9	4400	3.6	5400	4.1	6250	5.5	8230	8.0	11800	9.4	13800
M6	4.9	6230	6.1	7640	7.0	8840	9.3	11600	13.6	16700	15.9	19500
M8	12.0	11400	14.8	13900	16.9	16100	22.5	21200	33.0	30400	38.7	35500
M10	23.7	18000	29.2	22000	33.4	25500	44.6	33700	65.4	48100	76.6	56300
M12	41.3	26100	51.0	32000	58.3	37100	77.7	48900	114.1	70000	133.5	81800
M14	65.7	35600	81.2	43700	92.7	50600	123.7	66700	181.6	95500	212.5	112000
M16	102.5	48700	126.6	59700	144.7	69100	192.9	91000	283.4	130000	331.6	152000
M18	141.0	59500	174.2	73000	199.1	84500	273.7	115000	389.8	159000	456.2	186000
M20	199.9	76000	247.0	93100	282.2	108000	388.1	147000	552.7	203000	646.8	238000
M22	272.0	93900	336.0	115000	384.0	133000	528.0	182000	751.9	252000	879.9	294000
M24	345.7	109000	427.0	134000	488.0	155000	671.0	212000	955.7	293000	1118.3	342000
M27	505.6	142000	624.6	174000	713.8	202000	981.5	275000	1397.9	381000	1635.9	445000
M30	686.7	174000	848.2	213000	969.4	247000	1332.9	337000	1898.4	466000	2221.6	544000
M33	934.4	215000	1154.3	264000	1319.2	305000	1813.8	416000	2583.4	576000	3023.1	673000

The torque values listed are based on the clamp force (tension) applied to hexagon metric coarse thread bolt and coefficient of friction 0.2 (guidance only). Select the best tool for your application.

Model name of Impact Wrenches

Example	UW	-	6SH	L	K
			6SH (pistol grip for 6mm bolt*) 6SSH (straight handle) 6CSH (angle head) 6AS (45 degree angle head) ST (for stud bolt) P (pistol grip only for UW-140 · 220 · 381 series)	L (long anvil) R (rear exhaust)	K (light weight) DK (driver type anvil · light weight)

*Exception: UW-140 series =14mm bolt, UW-220 series =22mm, UW-381 series=38mm, UW-401 series=40mm and UW-550 = 55 mm

Socket Retaining Methods

Please specify the type of Anvil when ordering.

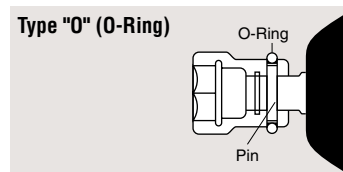
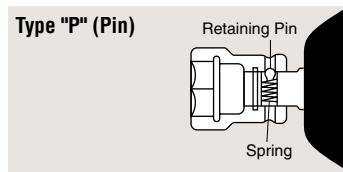
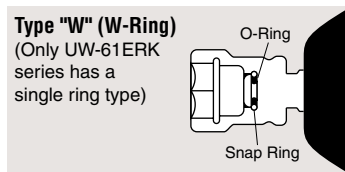

Double-Hammer mechanism

Powerful & fast assembly for highest productivity with well-balanced hammer mechanism and less torque reaction to operator. Recommended for general high-volume assembly such as motor vehicles, appliances, machinery and so forth.

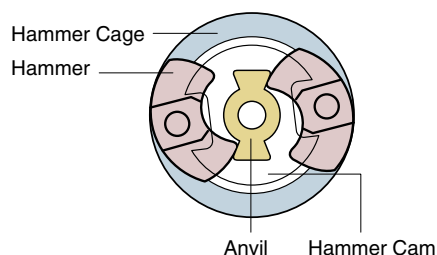

Swing-Hammer mechanism

Powerful & durable impacting mechanism with one piece Hammer-Hammer pin. Recommended to steel erection, refineries, mines, heavy motor vehicle industries and etc. (UW-140P, 220P, 251P, and 381 series)

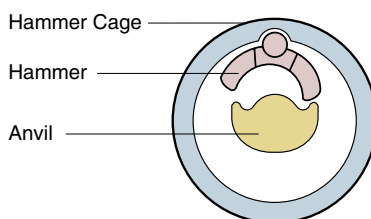

TORQUE CHART

To avoid excess wear of the parts, the tightening time is recommended not to exceed 5 seconds.

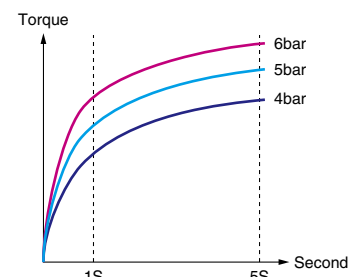

RECOMMENDED TORQUE CHART OF THE IMPACT WRENCHES

Fastening force of the impact wrenches changes in accordance to the fastening time and the bolt size.

This table shows various common fastening torque. Please use this table as just guide line when selecting the model.

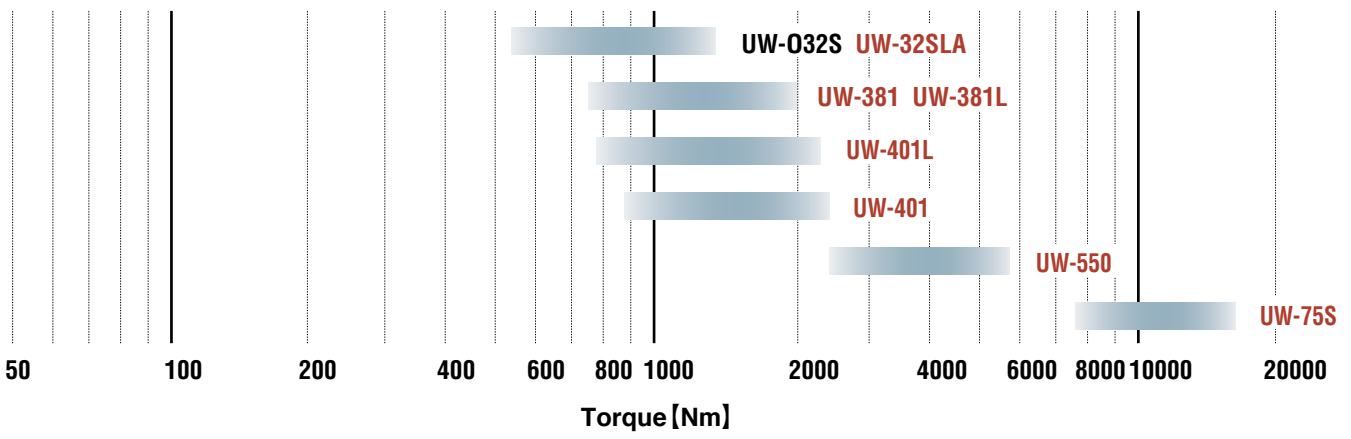
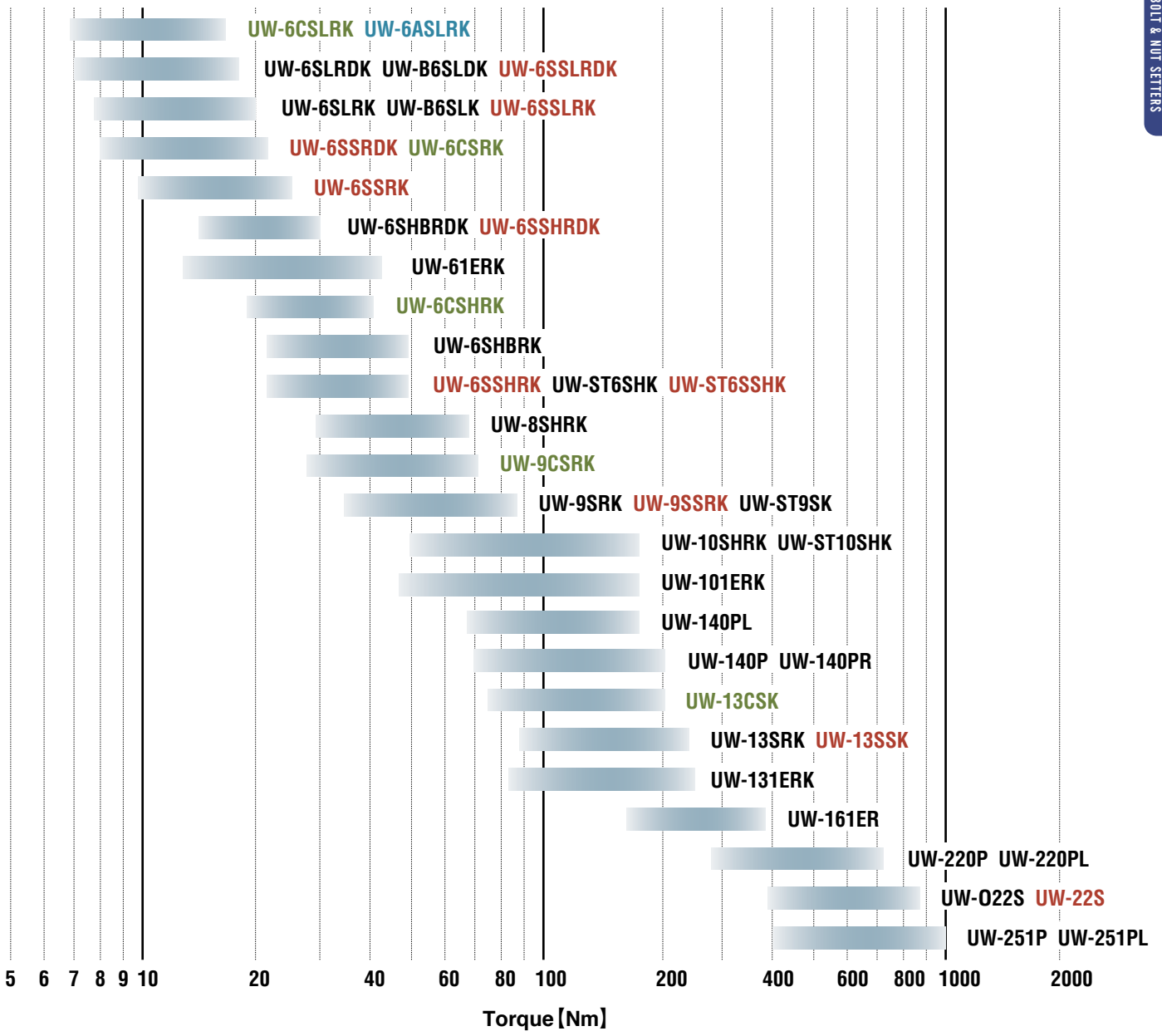
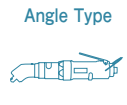
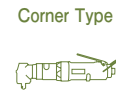
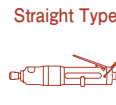
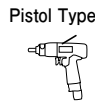

IMPACT WRENCHES

The widest range of URYU Impact Wrenches offer fast, powerful and economical operation in high-volume heavy assembly applications.

BOLT & NUT SETTERS



UW-6SLRK



UW-61ERK



UW-101ERK



UW-161ER



UW-6SHBRK



UW-B6SLK



UW-8SHRK



UW-10SHRK



UW-9SRK



UW-13SRK

Quick-change driver anvil type

On pulling the sleeve, insert or take off the bit.

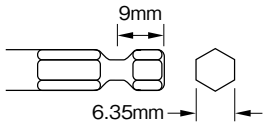

Please add "D" to each model name like UW-6SLRDK when ordering.

Built-in AIR REGULATOR FOR UW-61ERK,101ERK,131ERK, AND UW-161ER

Set "4" at the arrow mark for strongest and "1" for weakest.

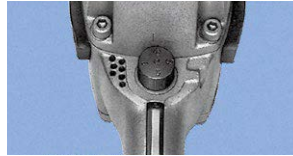

SPECIFICATIONS

Recommended Air Pressure : 0.6MPa (85psi)

Model	Capacity (Nominal Bolt Size)		Free Speed (about)	Overall Length less Socket (about)		Weight less Socket (about)		From Center to Outside (about)		Sq. Drive Shank		Average Air Consumption		Code
	mm	in		mm	in	kg	lb	mm	in	mm	in	m ³ /min	ft ³ /min	
UW-6SLRK	6	1/4	8500	175	6 57/64	0.97	2.13	31.0	1 7/32	9.5	3/8	0.35	12.4	00472
UW-6SHBRK	8	5/16	7300	154	6 1/16	1.36	2.99	28.0	1 7/64	9.5	3/8	0.35	12.4	02772
UW-B6SLK	6	1/4	8500	166	6 17/32	0.97	2.13	31.0	1 7/32	9.5	3/8	0.30	10.5	04042
UW-8SHRK	8	5/16	7300	172	6 49/64	1.55	3.41	31.0	1 7/32	12.7	1/2	0.40	14.0	03172
UW-9SRK	10	3/8	7000	178	7 1/64	1.79	3.93	34.0	1 11/32	12.7	1/2	0.45	16.0	04172
UW-10SHRK	10-12	3/8-1/2	6000	183	7 13/64	2.13	4.68	35.0	1 3/8	12.7	1/2	0.45	16.0	05072
UW-13SRK	13	1/2	6000	215	8 15/32	2.70	5.74	37.5	1 15/32	12.7	1/2	0.45	16.0	06372

Air Hose Size (Inside Diameter) : 9.5mm (3/8")

Air Inlet Thread : NPT1/4"

SPECIFICATIONS

Recommended Air Pressure:0.6MPa(85psi)

Model	Capacity (Nominal Bolt Size)		Free Speed (about)	Overall Length less Socket (about)		Weight less Socket (about)		From Center to Outside (about)		Sq. Drive Shank		Average Air Consumption		Code
	mm	in		mm	in	kg	lb	mm	in	mm	in	m ³ /min	ft ³ /min	
UW-61ERK	8	5/16	7300	150	5 29/32	1.51	3.32	29.5	1 5/32	9.5	3/8	0.35	12.4	03102
UW-101ERK	10	3/8	5500	179	7 3/64	2.27	4.99	36.0	1 27/64	12.7	1/2	0.45	16.0	05532
UW-131ERK	13	1/2	5500	205	8 5/64	2.97	6.53	37.5	1 15/32	12.7	1/2	0.55	19.4	06742
UW-161ER	16	5/8	3800	217	8 35/64	4.10	9.00	41.5	1 41/64	19.0	3/4	0.65	23.0	07992

Air Hose Size (Inside Diameter) : 12.7mm (1/2") for UW-161ER 9.5mm (3/8") for UW-61ERK, 101ERK & 131ERK series
 Air Inlet Thread (Pipe Tap) : NPT 3/8" for UW-161ER NPT 1/4" for UW-61ERK, 101ERK & 131ERK series



UW-6SSLRK



UW-32SLA (OUT-SHORT)



UW-401L (OUT-I)



UW-6SSHRK



UW-22S (SHORT)



UW-6CSHRK



UW-6CSLRK



UW-6ASLRK



UW-13CSK

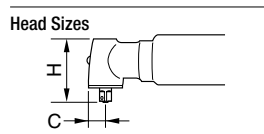

Model	C		H	
	mm	in	mm	in
UW-6CSLRK	13.5	17/32	59.5	2 11/32
UW-6CSRK	15.0	19/32	60.0	2 23/64
UW-6CSHRK	17.5	11/16	65.0	2 9/16

Model	C		H	
	mm	in	mm	in
UW-9CSRK	22.0	7/8	85.0	3 11/32
UW-13CSK	26.0	11/32	102.0	4 7/32

SPECIFICATIONS

Recommended Air Pressure : 0.6MPa (85psi)

Model	Capacity (Nominal Bolt Size)		Free Speed (about) min ⁻¹	Overall Length less Socket (about)		Weight less Socket (about)		From Center to Outside (about)		Sq. Drive or Hex. Size		Average Air Consumption		Code
	mm	in		mm	in	kg	lb	mm	in	mm	in	m ³ /min	ft ³ /min	
UW-6SSLRK	6	1/4	8500	239	9 13/32	0.87	1.91	31.0	1 7/32	9.5	3/8	0.30	10.5	00672
UW-6SSRK	6	1/4	7500	225	8 55/64	0.97	2.13	29.5	1 5/32	9.5	3/8	0.30	10.5	01272
UW-6SSHRK	8	5/16	7300	249	9 51/64	1.26	2.77	27.5	1 5/64	9.5	3/8	0.35	12.4	01972
UW-6CSLRK	6	1/4	8000	258	10 5/32	1.17	2.57	31.0	1 7/32	9.5	3/8	0.30	10.5	00872
UW-6CSRK	6	1/4	7300	257	10 1/8	1.42	3.12	29.5	1 5/32	9.5	3/8	0.30	10.5	01472
UW-6CSHRK	8	5/16	7300	282	11 7/64	1.71	3.76	27.5	1 5/64	9.5	3/8	0.30	10.5	02072
UW-6ASLRK	6	1/4	6500	277	10 29/32	1.14	2.50	31.0	1 7/32	9.5	3/8	0.30	10.5	00972
UW-9SSRK	10	3/8	7000	320	12 19/32	2.10	4.62	34.0	1 11/32	12.7	1/2	0.45	16.0	04272
UW-13SSK	13	1/2	6300	281	11 1/16	3.17	6.97	39.0	1 17/32	12.7	1/2	0.55	19.4	06532
UW-9CSRK	10	3/8	7000	359	14 9/64	2.78	6.11	34.0	1 11/32	12.7	1/2	0.35	12.4	04372
UW-13CSK	13	1/2	6500	374	14 23/32	5.17	11.37	39.0	1 17/32	12.7	1/2	0.75	26.5	06672
UW-6SSLRDK	6	1/4	8500	245	9 21/32	0.87	1.98	31.0	1 7/32	6.35	1/4	0.30	10.5	00772
UW-6SSRDK	6	1/4	7500	241	9 31/64	0.97	2.20	29.5	1 5/32	6.35	1/4	0.30	10.5	01372
UW-6SSHRDK	8	5/16	7300	265	10 7/16	1.26	2.75	27.5	1 5/64	6.35	1/4	0.35	12.4	01992

Air Hose Size (Inside Diameter) : 9.5mm (3/8") Air Inlet Thread : NPT1/4"

SPECIFICATIONS

Recommended Air Pressure : 0.6MPa (85psi)

Model	Capacity (Nominal Bolt Size)		Free Speed (about) min ⁻¹	Overall Length less Socket (about)		Weight less Socket (about)		From Center to Outside (about)		Sq. Drive Shank		Average Air Consumption		Code
	mm	in		mm	in	kg	lb	mm	in	mm	in	m ³ /min	ft ³ /min	
UW-22S	22	7/8	4000	395	15 35/64	7.90	17.41	50.0	1 31/32	19.0	3/4	0.75	26.5	08612
UW-22S(L)	22	7/8	4000	518	20 25/64	8.30	18.30	50.0	1 31/32	19.0	3/4	0.75	26.5	08662
UW-O22S	22	7/8	3800	257	10 1/8	7.65	16.80	50.0	1 31/32	19.0	3/4	0.75	26.5	08712
UW-O32S	32	1 1/4	3500	304	11 31/32	11.60	25.50	61.0	2 13/32	25.4	1	1.15	40.6	09512
UW-32SLA	32	1 1/4	3500	438	17 1/4	11.70	25.74	62.5	2 29/64	25.4	1	0.90	32.0	09112
UW-32SLA(L)	32	1 1/4	3500	583	22 61/64	12.50	27.50	62.5	2 29/64	25.4	1	0.90	32.0	09212
UW-401	38	1 1/2	3200	494	19 29/64	15.10	33.22	62.5	2 29/64	25.4	1	1.20	42.4	11362
UW-401L	38	1 1/2	3200	654	25 3/4	16.50	36.30	62.5	2 29/64	25.4	1	1.20	42.4	11172

Air Hose Size (Inside Diameter) : 12.7mm (1/2")
Air Inlet Thread : NPT3/8" for UW-22S, UW-O22S & UW-O32S NPT1/2" for UW-32SLA & UW-401

IMPACT WRENCHES

SWING HAMMER SERIES

BOLT & NUT SETTERS



UW-140PR



UW-140P



UW-220P



UW-251P



UW-381

Paint color of the actual product may be different from the images.



Suffix "L" to Model Name.

Head Sizes

Model	L		Model	L	
	mm	in		mm	in
UW-140PL	68.5	2 45/64	UW-381L	200.0	7 7/8
UW-220PL	150.0	5 29/32	UW-381PL	200.0	7 7/8
UW-251PL	151.0	5 15/16	UW-401L	199.5	7 55/64

SPECIFICATIONS

Recommended Air Pressure : 0.6MPa (85psi)

Model	Capacity (Nominal Bolt Size)		Free Speed (about)	Overall Length less Socket (about)		Weight less Socket (about)		From Center to Outside (about)		Sq. Drive Shank		Average Air Consumption		Code
	mm	in		mm	in	kg	lb	mm	in	mm	in	m ³ /min	ft ³ /min	
UW-140P	12	1/2	6500	200	7 7/8	2.70	5.90	33.0	1 19/64	12.7	1/2	0.70	25.0	07032
UW-140PR	12	1/2	6500	200	7 7/8	2.70	5.90	33.0	1 19/64	12.7	1/2	0.70	25.0	07242
UW-140PL	12	1/2	6800	244	9 39/64	2.80	6.10	33.0	1 19/64	12.7	1/2	0.70	25.0	07082
UW-140PRL	12	1/2	6800	244	9 39/64	2.80	6.10	33.0	1 19/64	12.7	1/2	0.70	25.0	07272
UW-220P	22	7/8	5500	230	9 1/16	4.40	9.60	42.0	1 21/32	19.0	3/4	0.70	25.0	08232
UW-220PL	22	7/8	5500	350	13 25/32	4.70	10.30	42.0	1 21/32	19.0	3/4	0.70	25.0	08252
UW-251P	25	1	5500	276	10 55/64	8.00	17.60	51.5	2 1/32	25.4	1	0.80	28.0	09122
UW-251PL	25	1	5500	395	15 35/64	8.80	19.40	51.5	2 1/32	25.4	1	0.80	28.0	09152
UW-381	38	1 1/2	4700	395	15 35/64	9.50	20.90	58.5	2 19/64	25.4	1	0.90	31.5	11612
UW-381L	38	1 1/2	4700	543	21 3/8	10.00	22.00	58.5	2 19/64	25.4	1	0.90	31.5	11632
UW-381P	38	1 1/2	4700	276	10 55/64	9.50	20.90	58.5	2 19/64	25.4	1	0.90	31.5	11652
UW-381PL	38	1 1/2	4700	425	16 47/64	10.00	22.00	58.5	2 19/64	25.4	1	0.90	31.5	11672

Air Hose Size (Inside Diameter) : 9.5mm(3/8") for UW-140P Series, 12.7mm (1/2") for other models above

Air Inlet Thread : NPT 1/4" for UW-140P series

NPT 3/8" for UW-220P, UW-251P Series

NPT 1/2" for UW-381 Series

UW-140P Series combine compact size and light weight with torque, 70 – 200 Nm to meet a wide range of applications. Recommendable for overall automotive service, body shop etc.

UW-220P Series are recommendable for various popular fastening joints in general industry. (300-700Nm)

UW-251P Series are recommendable for heavy industrial production work such as engine work, truck springs, tractor pads, off-road equipment and heavy duty farm equipment.(600 – 1000Nm)

UW-381 Series are powerful, light-weight impact wrenches that are ideal for wide applications (1400 - 2000 Nm) in steel erection refineries, petrochemical plants, mines, steel mills and heavy motor vehicle plants.

JUMBO TYPE IMPACT WRENCHES

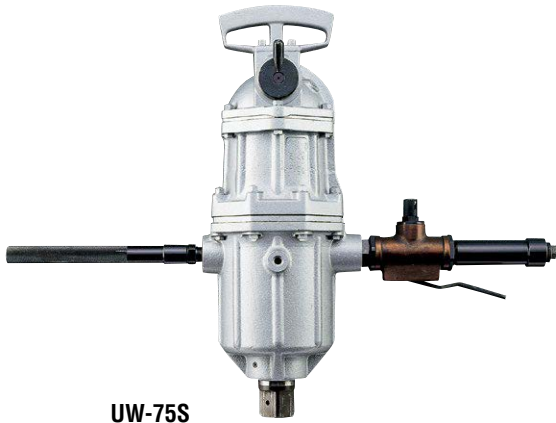

UW-75S



UW-550

Built-In Air Regulator

Pull up the spring loaded knob and turn clockwise to lower the power and anticlockwise to increase it, then reset.

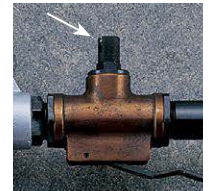

SPECIFICATIONS

Recommended Air Pressure : 0.6MPa (85psi)

Model	Capacity (Nominal Bolt Size)		Free Speed (about)	Overall Length less Socket (about)		Weight less Socket (about)		From Center to Outside (about)		Sq. Drive Shank		Average Air Consumption		Code
	mm	in		mm	in	kg	lb	mm	in	mm	in	m ³ /min	ft ³ /min	
UW-550	55	2 1/4	3500	525	20 43/64	36.0	79.2	78.0	3 5/64	38.1	1 1/2	2.20	79	11742
UW-75S	75	3	1400	670	26 3/8	56.0	123.0	96.0	3 25/32	44.4	1 3/4	3.20	114	12012
UW-75S (1 1/2)	76	3	1400	670	26 3/8	56.0	123.0	96.0	3 25/32	38.1	1 1/2	3.20	114	12062

Air Hose Size (Inside Diameter) : 19.0 mm (3/4")
Air Inlet Thread : NPT1"

STUD BOLT WRENCHES



UW-ST6SHK



UW-ST6SSHK



UW-ST9SK

FEATURES

Double-Hammer Auto-Reversing for Stud Bolt Driving

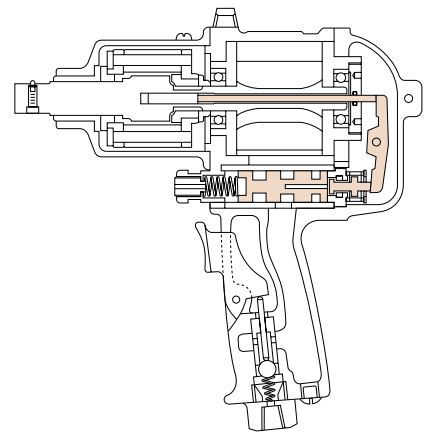

These unique Auto-Reversing tools simply stud-bolt driving (frequent reversing) job considerably for less operator's fatigue & high productivity. Push the tool forward to the work for driving and simply pull it back.

SPECIFICATIONS

Recommended Air Pressure : 0.6MPa (85psi)

Model	Capacity (Nominal Bolt Size)		Free Speed (about)	Overall Length less Socket (about)		Weight less Socket (about)		From Center to Outside (about)		Sq. Drive Shank		Average Air Consumption		Code
	mm	in		mm	in	kg	lb	mm	in	mm	in	m ³ /min	ft ³ /min	
UW-ST6SHK	8	5/16	6500	171	6 47/64	1.70	3.74	28.5	1 1/8	9.5	3/8	0.40	14.0	02132
UW-ST9SK	10	3/8	6300	192	7 9/16	2.35	5.06	33.5	1 5/16	12.7	1/2	0.50	17.6	04432
UW-ST10SHK	10-12	3/8-1/2	6300	194	7 41/64	2.60	5.72	33.5	1 5/16	12.7	1/2	0.50	17.6	04472
UW-ST6SSHK	6-8	1/4-5/16	6500	235	9 1/4	1.35	2.97	28.5	1 1/8	9.5	3/8	0.40	14.0	02172

Air Hose Size (Inside Diameter) : 9.5mm (3/8")
Air Inlet Thread : NPT1/4"

UTM-1500 SERIES

UTM-1500 informs you of error by display and buzzer when all bolts are not tightened up firmly. This enables you to do "Pokayoke" for secure tightening.



UTM-1500(PS): Pressure Sensor Incorporated type
By connecting the TM signal hose from a tool to the coupler at the back of the controller, the pressure sensor incorporated in the controller converts the air pressure signal into the electric signal.



UTM-1500(CN): Connector Incorporated type
By connecting the pressure sensor (external pressure sensor assembly) attached to a tool to the connector at the back of controller, the controller supplies the power and loads the analog signal.

FEATURES

- Applicable to the pneumatic tools such as the oil pulse wrenches, impact wrenches etc. (Tool should be modified into the TM type because the controller basically detects the back pressure.)
- Counting down the fastening number, error proofing by the display and buzzer.
- Easy parameter setup the controller by front key switches followed to the front panel LCD. (It is possible to setup the parameters through a personal computer as well.) *TM convertible model : Various kinds of tools can be converted into TM type. Please ask your local URYU distributor for details.

[FUNCTIONS]

- Easy setup for the pressure values by the automatic setup future.
- Up to 1500 tightening time and judging data points stored.
- Each buzzer volume level of fastening recognition, panel and NOK operation adjustable.
- Work select feature available for four different works with different numbers of fasteners.
- By equipping the external input/output terminal block (free format), inter lock with the line is possible.
- Parameters receivable/ transmittable, and wave data, memory data and the total numbers of fasteners receivable through PC.(Total numbers of pulse receivable in usage of the external pressure sensor assembly.)
- Measurement and display of the fastening time possible for the shut off tools.
- External pressure sensor assembly equipped for UTM-1500(CN) enables to count the pulse number so that the pulse number control becomes possible other than the fastening time control. (The pulse number cannot be detected sometimes depending on a tool or working conditions.)
- Total maintenance determined the total numbers of fasteners or pulse possible. (external pressure sensor assembly needed.)

UTM-1500 (RA) :
Rack Type



Model	Voltage & Frequency	Operating ambient temperature & humidity	Dimensions mm(in)	Weight Kg(lb)	Code(A/E)
UTM-1500A/E (PS)	115V / 230V 50Hz / 60Hz	0 - 36 degree (no freeze) less 90%RH (no dewfall)	200 × 210 × 100 (7 7/8 × 8 17/64 × 3 15/16)	2.0 (4.47)	82832/82842
UTM-1500A/E (CN)				2.0 (4.47)	82892/82902
UTM-1500A/E (RA-PS)	115V / 230V 50Hz / 60Hz	0 - 36degree (no freeze) less 90%RH (no dewfall)	280 × 220 × 420 (11 1/32 × 8 21/32 × 16 17/32) (c/w rack)	6.4 (14.15)	82862/82872
UTM-1500A/E (RA-CN)				6.4 (14.15)	82932/82942

* TM convertible model : Various kinds of tools can be converted into TM type. Please ask your local URYU distributor for details.
UTM-1500A is the 115V use, while UTM-1500E is the 230V use.

OPTION

Twin Spiral Hose Assembly

Twin Spiral Hose Assembly : Please ask your local URYU distributor for details.

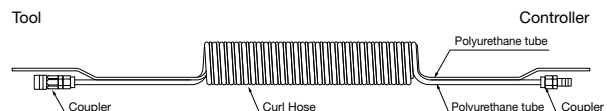

TM Tool Connection

Shut-off Tool

- UTM-1500(CN) & External Pressure Sensor Assembly
*Please place the external pressure sensor assembly to a tool as close as possible. In use of the pulse number count, external pressure sensor assembly should be attached near a tool handle.

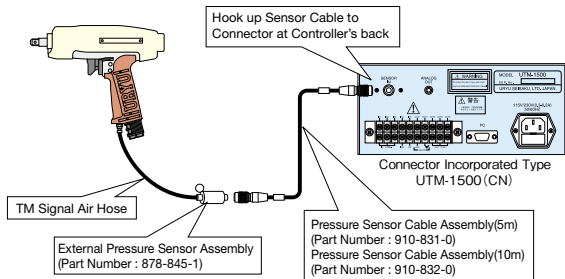

- UTM-1500(RA-CN) & External Pressure Sensor Assembly
*Same wiring as in the case of UTM-1500(CN) & External Pressure Sensor Assembly (left figure)

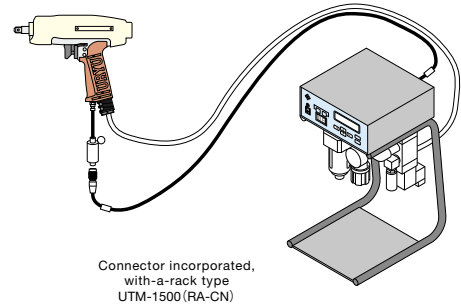

- UTM-1500(PS)

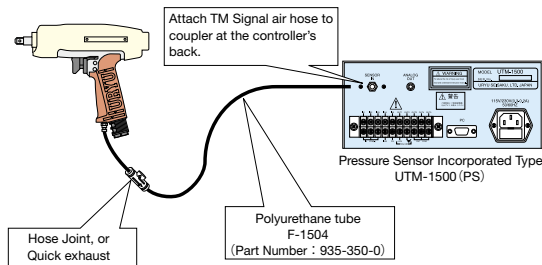

- UTM-1500(PS) or (CN) & Relay Box Assembly

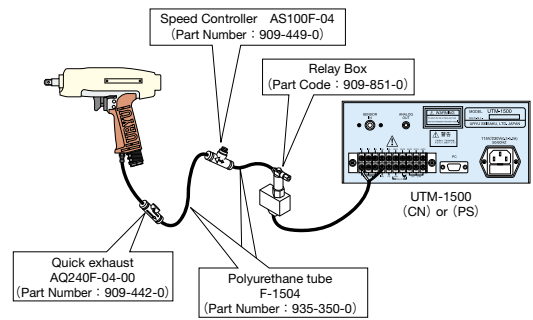

- UBX-T(RF8) Series or BP-T(RF8) Series

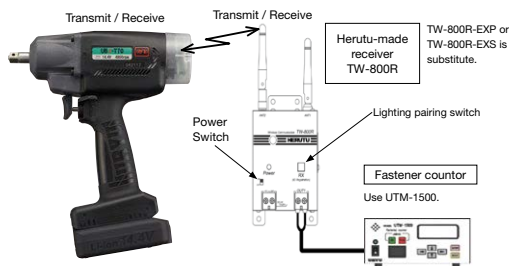

- UBX-T(Z) Series or BP-T(Z) Series

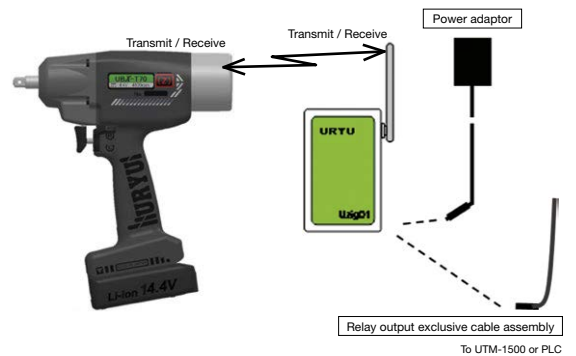

Non Shut-off Tool

- UTM-1500(CN)
Solenoid valve is incorporated in the rack type, UTM-1500(RA-CN), so that you only need to connect a tool to controller.

- UTM-1500(PS)
Referring to the right layout, please connect the TM signal Hose(φ4) from a tool to the connector at the back of the controller.

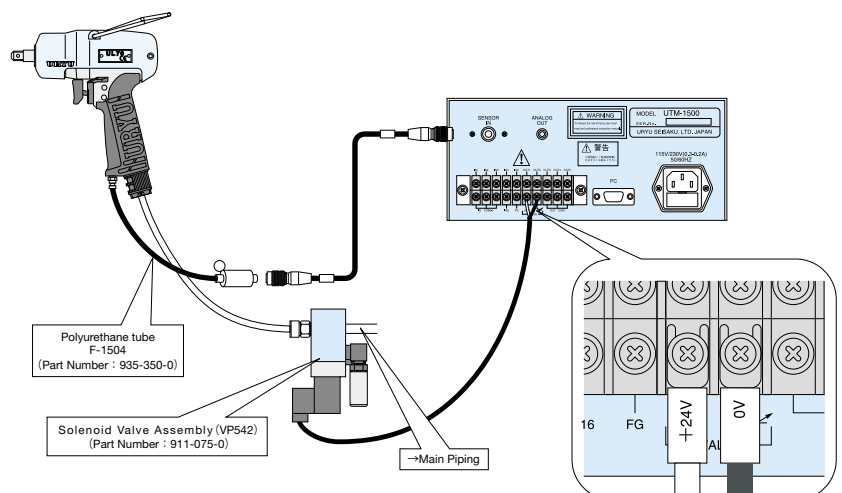

NUTRUNNERS

By transmitting the force of air motor or electric motor to output shaft using only the reduction gear, it makes possible to suppress noise and vibration. Also, it enables an excellent durability.

URYU Multiple Nutrunners are now very popular in various modern industries, especially in automobile assembly lines, where two or more bolts or nuts must be tightened simultaneously uniform torque. URYU can design and manufacture the complete machine to meet customers' demands besides components individual supply. Please feel free to contact local URYU distributors.



Electric Nutrunner



Air Nutrunner and minimum torque sensor

Setting Layout

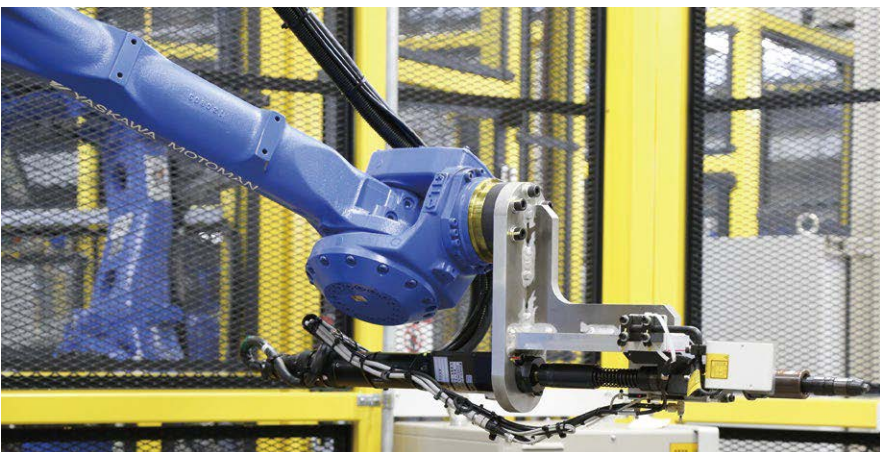
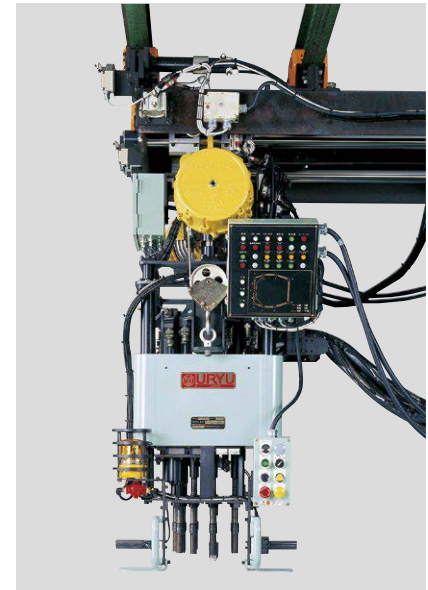
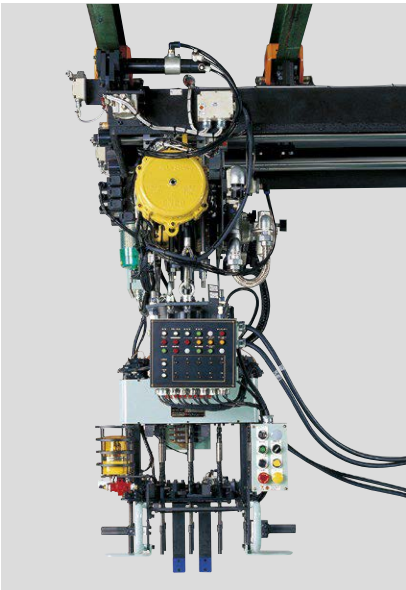

*ISO 9001 is not applied to the nutrunner system

SCREW DRIVERS

TORQUE CONTROL SCREWDRIVERS

CUSHION CLUTCH TYPE SCREWDRIVERS

DIRECT DRIVE SCREWDRIVERS

IMPACT SCREWDRIVERS

SELECTION GUIDE

Joint & Torque Curve	Feature	Clutch Type	Model	A	B	C
Free Running Hard Stop 	Turns easily until head seats, then instant resistance to torque build-up.	Oil-Pulse	U & UX	⊙	⊙	⊙
		Oil-Pulse	UAT,ULT & UL	⊙	⊙	⊙
		Impact	UW & US-○○W	×	○	×
		Torque Control	US-LT series	○	⊙	⊙
		Direct Drive	US-LD series	○	○	○
Cushion	Other US series	○	○	○		
Soft Stop 	Turns easily until head seats, Gradual resistance as material compresses.	Oil-Pulse	U & UX	⊙	⊙	⊙
		Oil-Pulse	UAT,ULT & UL	⊙	⊙	⊙
		Impact	UW & US-○○W	×	○	×
		Torque Control	US-LT series	○	⊙	⊙
		Direct Drive	US-LD series	○	○	○
Cushion	Other US series	○	○	○		
Self-Tapping Thick Material 	Constant heavy resistance until head seats. Then gradual or sudden build-up.	Oil-Pulse	U & UX	⊙	○	○
		Impact	UW & US-○○W	×	○	×
		Torque Control	US-LT series	×	×	×
		Direct Drive	US-LD series	○	○	○
		Cushion	Other US series	○	○	○
Self-Tapping Sheet Metal 	Increasing resistance followed by easing then sudden build-up as head seats.	Oil-Pulse	U, UX & UL	⊙	⊙	⊙
		Impact	UW & US-○○W	×	○	×
		Torque Control	US-LT series	×	×	×
		Direct Drive	US-LD series	○	○	○
		Cushion	Other US series	○	○	○
Self-Tapping Plastic 	Constant heavy resistance until head seats. Then gradual or sudden build-up.	Oil-Pulse	U, UX & UL	⊙	⊙	⊙
		Impact	UW & US-○○W	×	×	×
		Torque Control	US-LT series	○	⊙	⊙
		Direct Drive	US-LD series	○	○	○
		Cushion	Other US series	○	○	○
Wood Screws 	Small starting resistance which increases as screw is driven in. Heavier resistance when head seats.	Oil-Pulse	U & UX	○	○	○
		Oil-Pulse	UL	⊙	⊙	⊙
		Impact	UW & US-○○W	×	×	×
		Torque Control	US-LT series	×	×	×
		Direct Drive	US-LD series	○	⊙	⊙
Cushion	Other US series	○	○	○		

Remarks : A=Ergonomics B=Job Efficiency C=Torque Accuracy Recommendation : ⊙=Excellent ○=Good ×=Not Recommended

Accessories

Group of Tools

A	US-LT○○A/AL,US-3.5A,US-4,US-40,US-4PB
B	US-○○W/PW,US-450WB,US-LT○○B/BL/PB,US-5,US-50,US-5PB
C	US-LT10B
D	US-LT30B-○○C,US-LT40B-○○C,US-3.5ACB,US-4CA,US-5CA

(+) PHILLIPS BITS

Group	Bit	(L)		Part Number		
		mm	In	No.1	No.2	No.3
A		120	4 23/32	916-306-0	916-316-0	916-321-0
B		100	3 15/16	916-401-0	916-411-0	916-421-0
		75	2 61/64	916-800-0	916-810-0	916-820-0
C		50	1 21/32	916-137-0	—	—
D		30	1 37/64	916-501-0	916-511-0	916-521-0

HEXAGONAL WRENCH BIT

Group	B, C				
BIT					
	Dimensions				Part Number
Dimensions / Part Number	A		(L)		
	mm	in	mm	in	
	4	1/8	75	2 61/64	867-172-1
5	13/64	75	2 61/64	867-176-1	
6	15/64	75	2 61/64	867-121-1	

HEXAGONAL SOCKET BITS

Group	Bit	Dimensions										Part Number
		A		B		C		D		E		
		mm	in	mm	in	mm	in	mm	in	mm	in	
A		12	15/32	100	3 15/16	4.5	11/64	8	5/16	30	1 37/64	918-109-0
B		16	8/5	50	1 31/32	5.5	7/32	10	25/64	15	19/32	918-259-0
		16	8/5	75	2 61/64	5.5	7/32	10	25/64	25	63/64	918-215-0
		16	8/5	100	3 15/16	5.5	7/32	10	25/64	30	1 37/64	918-216-0
		16	8/5	150	5 29/32	5.5	7/32	10	25/64	30	1 37/64	918-237-0
D		18	45/64	100	3 15/16	7	9/32	12	15/32	30	1 37/64	918-222-0
D		16	8/5	31	1 7/32	5.5	7/32	10	25/64	7	9/32	918-307-0

*Please ask your local URYU distributor for other bit size.

SELECTION CHART

Fastening force of the screwdrivers changes in accordance to the fastening time and the bolt size. This table shows various common fastening torque. Please use this table as just guide line when selecting the model.

Pistol Type



Push-Start Type



Lever-Start Type



Corner Type



TORQUE-CONTROL TYPE

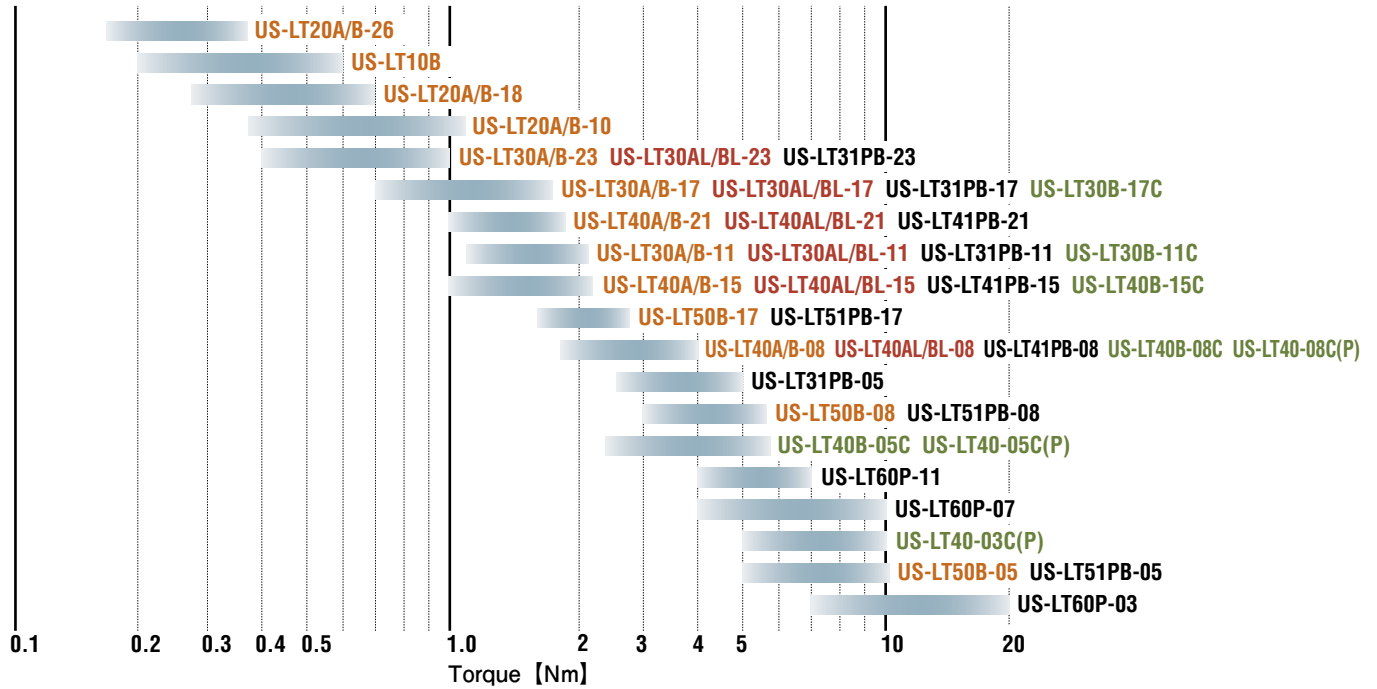

CUSHION CLUTCH TYPE

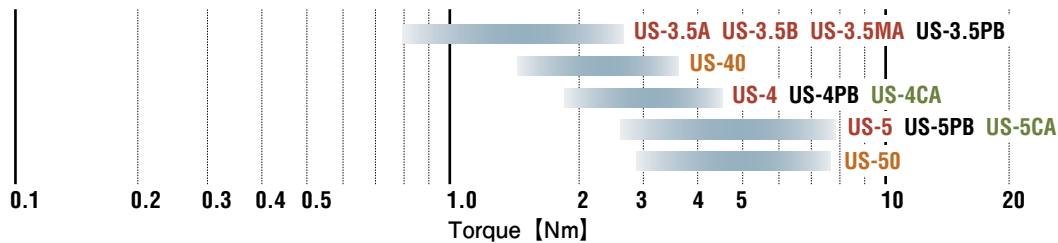

DIRECT DRIVE TYPE

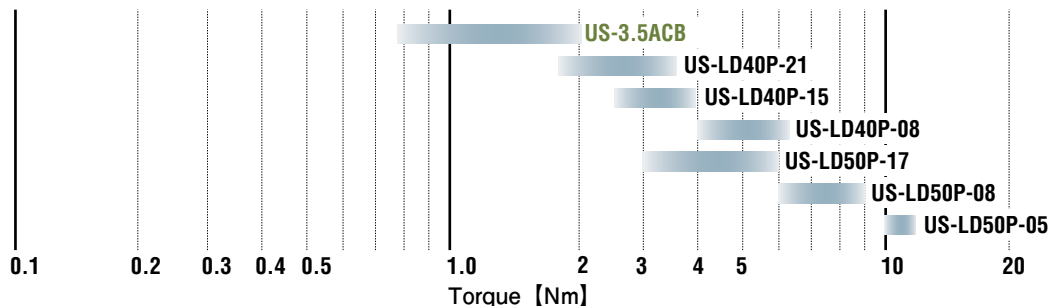

IMPACT TYPE

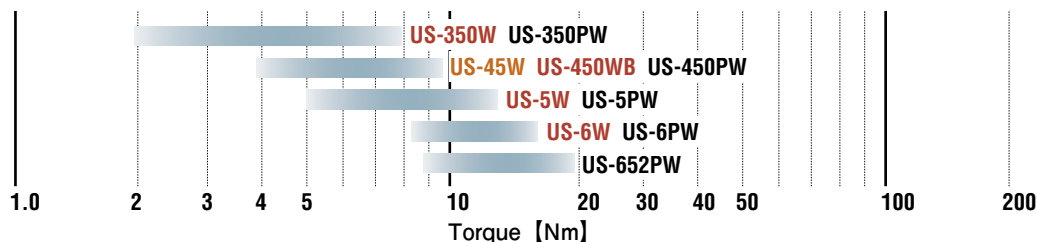

TORQUE CONTROL SCREWDRIVERS

US-LT drivers enable you to set the shut-off torque. These small and light-weight screwdrivers contributes to reducing operators' fatigue and to better productivity.



US-LT10B



US-LT20A-10



US-LT30A-17



US-LT30B-11



US-LT40A-08



US-LT50B-05



US-LT30AL-17



US-LT30BL-11



US-LT40AL-15



US-LT40BL-15



US-LT40BL-08

SPECIFICATIONS

Recommended Air Pressure : 0.5MPa (72psi)

Model	Capacity (Screw Size)		Torque Range		Free Speed (Approx.)	Overall Length (about)		Weight less Bit (about)		From Center to Outside (about)		Air Hose Size (inside Dia.)		Average Air Consumption		Code
	mm	in	Nm	in-lbs	min ⁻¹	mm	in	kg	lb	mm	in	mm	in	m ³ /min	ft ³ /min	
US-LT10B	2.6	No.3	0.20-0.60	1.8-5.3	1000	191	7 33/64	0.29	0.63	12.0	31/64	6.35	1/4	0.15	5.2	47362
US-LT20A-26	2.2	No.2	0.15-0.35	1.3-3.1	2600	180	7 3/32	0.34	0.68	13.0	33/64	6.35	1/4	0.16	5.6	47032
US-LT20B-26	2.2	No.2	0.15-0.35	1.3-3.1	2600	180	7 3/32	0.34	0.68	13.0	33/64	6.35	1/4	0.16	5.6	47042
US-LT20A-18	2.6	No.3	0.25-0.70	2.2-6.2	1800	180	7 3/32	0.34	0.68	13.0	33/64	6.35	1/4	0.16	5.6	47052
US-LT20B-18	2.6	No.3	0.25-0.70	2.2-6.2	1800	180	7 3/32	0.34	0.68	13.0	33/64	6.35	1/4	0.16	5.6	47062
US-LT20A-10	3	No.5	0.35-1.10	3.1-9.68	1000	180	7 3/32	0.34	0.68	13.0	33/64	6.35	1/4	0.16	5.6	47072
US-LT20B-10	3	No.5	0.35-1.10	3.1-9.68	1000	180	7 3/32	0.34	0.68	13.0	33/64	6.35	1/4	0.16	5.6	47082
US-LT30A-23	3	No.5	0.40-1.00	3.5-8.8	2300	187	7 23/64	0.43	0.94	15.5	39/64	6.35	1/4	0.20	7.0	47122
US-LT30B-23	3	No.5	0.40-1.00	3.5-8.8	2300	187	7 23/64	0.43	0.94	15.5	39/64	6.35	1/4	0.20	7.0	47132
US-LT30A-17	3.5	No.6	0.70-1.50	6.2-13.2	1700	187	7 23/64	0.43	0.94	15.5	39/64	6.35	1/4	0.20	7.0	47142
US-LT30B-17	3.5	No.6	0.70-1.50	6.2-13.2	1700	187	7 23/64	0.43	0.94	15.5	39/64	6.35	1/4	0.20	7.0	47152
US-LT30A-11	4	No.8	1.10-2.10	9.7-18.5	1100	187	7 23/64	0.43	0.94	15.5	39/64	6.35	1/4	0.20	7.0	47162
US-LT30B-11	4	No.8	1.10-2.10	9.7-18.5	1100	187	7 23/64	0.43	0.94	15.5	39/64	6.35	1/4	0.20	7.0	47172
US-LT40A-21	4	No.8	1.00-1.70	6.2-15.0	2100	209	8 15/64	0.65	1.43	16.5	41/64	6.35	1/4	0.30	10.5	47222
US-LT40B-21	4	No.8	1.00-1.70	6.2-15.0	2100	209	8 15/64	0.65	1.43	16.5	41/64	6.35	1/4	0.30	10.5	47232
US-LT40A-15	4	No.8	1.00-2.20	6.2-19.4	1500	209	8 15/64	0.65	1.43	16.5	41/64	6.35	1/4	0.30	10.5	47242
US-LT40B-15	4	No.8	1.00-2.20	6.2-19.4	1500	209	8 15/64	0.65	1.43	16.5	41/64	6.35	1/4	0.30	10.5	47252
US-LT40A-08	5	No.10	1.60-4.00	14.1-35.2	800	209	8 15/64	0.65	1.43	16.5	41/64	6.35	1/4	0.30	10.5	47262
US-LT40B-08	5	No.10	1.60-4.00	14.1-35.2	800	209	8 15/64	0.65	1.43	16.5	41/64	6.35	1/4	0.30	10.5	47272
US-LT50B-17	4-5	No.8-No.10	1.50-2.60	9.7-23.0	1700	240	9 29/64	1.00	2.20	19.5	49/64	9.50	3/8	0.50	17.5	44422
US-LT50B-08	5-6	No.10-1/4	3.00-5.50	26.4-48.4	800	240	9 29/64	1.00	2.20	19.5	49/64	9.50	3/8	0.50	17.5	44432
US-LT50B-05	5-6	No.10-1/4	5.00-10.5	44.0-92.4	480	240	9 29/64	1.00	2.20	19.5	49/64	9.50	3/8	0.50	17.5	44442
US-LT30AL-23	3	No.5	0.40-1.00	3.52-8.8	2300	229	8 15/64	0.53	1.16	15.0	19/32	6.35	1/4	0.20	7.0	46622
US-LT30BL-23	3	No.5	0.40-1.00	3.52-8.8	2300	229	8 15/64	0.53	1.16	15.0	19/32	6.35	1/4	0.20	7.0	46632
US-LT30AL-17	3.5	No.6	0.70-1.50	6.2-13.2	1700	229	8 15/64	0.53	1.16	15.0	19/32	6.35	1/4	0.20	7.0	46642
US-LT30BL-17	3.5	No.6	0.70-1.50	6.2-13.2	1700	229	8 15/64	0.53	1.16	15.0	19/32	6.35	1/4	0.20	7.0	46652
US-LT30AL-11	4	No.6	1.10-2.10	9.7-18.5	1100	229	8 15/64	0.53	1.16	15.0	19/32	6.35	1/4	0.20	7.0	46662
US-LT30BL-11	4	No.6	1.10-2.10	9.7-18.5	1100	229	8 15/64	0.53	1.16	15.0	19/32	6.35	1/4	0.20	7.0	46672
US-LT40AL-21	4	No.8	1.00-1.70	8.8-15.0	2100	249	9 51/64	0.70	1.54	16.5	21/32	6.35	1/4	0.30	10.5	46722
US-LT40BL-21	4	No.8	1.00-1.70	8.8-15.0	2100	249	9 51/64	0.70	1.54	16.5	21/32	6.35	1/4	0.30	10.5	46732
US-LT40AL-15	4	No.8	1.00-2.20	8.8-19.4	1500	249	9 51/64	0.70	1.54	16.5	21/32	6.35	1/4	0.30	10.5	46742
US-LT40BL-15	4	No.8	1.00-2.20	8.8-19.4	1500	249	9 51/64	0.70	1.54	16.5	21/32	6.35	1/4	0.30	10.5	46752
US-LT40AL-08	5	No.10	1.60-4.00	14.1-35.4	800	249	9 51/64	0.70	1.54	16.5	21/32	6.35	1/4	0.30	10.5	46762
US-LT40BL-08	5	No.10	1.60-4.00	14.1-35.4	800	249	9 51/64	0.70	1.54	16.5	21/32	6.35	1/4	0.30	10.5	46772

Air Inlet Size : NPT1/8" for US-LT10/20 series
 NPT1/4" for US-LT30/40/50 series
 Hex. Size of Bit : 5mm (13/64") for A-Type
 6.35mm (1/4") for B-Type



US-LT31PB-05



US-LT51PB-05



US-LT60P-03

US-LT60P(P) Series

Optional 9.5mm (3/8") Sq. Drive Anvil is alternatively available. Suffix each model name with (P) as US-LT60P-03(P) or -07(P) when ordering.



Torque reaction bar should be attached for solid support to absorb the reaction when the tool comes to stall.

SPECIFICATIONS

Recommended Air Pressure : 0.5MPa (72psi)

Model	Capacity (Screw Size)		Torque Range		Free Speed (Approx.) min ⁻¹	Overall Length (about)		Weight less Bit (about)		From Center to Outside (about)		Air Hose Size (inside Dia.)		Average Air Consumption		Code
	mm	in	Nm	in-lbs		mm	in	kg	lb	mm	in	mm	in	m ³ /min	ft ³ /min	
US-LT31PB-23	2.6	No.3	0.40-1.00	3.5-8.8	2300	170	7 1/64	0.71	1.56	16.0	39/64	6.35	1/4	0.20	7.0	44222
US-LT31PB-17	2.2	No.2	0.70-1.50	6.2-13.2	1700	170	7 1/64	0.71	1.56	16.0	39/64	6.35	1/4	0.20	7.0	44232
US-LT31PB-11	2.6	No.3	1.10-2.10	9.7-18.5	1100	170	7 1/64	0.71	1.56	16.0	39/64	6.35	1/4	0.20	7.0	44242
US-LT31PB-05	3	No.5	2.40-5.00	21.1-44.0	500	189	8 3/16	0.85	1.87	16.0	39/64	6.35	1/4	0.20	7.0	44252
US-LT41PB-21	3	No.5	1.00-1.70	8.8-15.0	2100	175	7 23/32	0.87	1.91	17.0	41/64	6.35	1/4	0.30	10.5	44332
US-LT41PB-15	3.5	No.6	1.00-2.20	8.8-19.4	1500	175	7 23/32	0.87	1.91	17.0	41/64	6.35	1/4	0.30	10.5	44342
US-LT41PB-08	4	No.8	1.60-4.00	14.1-35.2	800	175	7 23/32	0.87	1.91	17.0	41/64	6.35	1/4	0.30	10.5	44352
US-LT51PB-17	4	No.8	1.50-2.60	13.2-22.9	1700	198	7 51/64	1.20	2.64	20.0	49/64	9.50	3/8	0.50	17.5	44562
US-LT51PB-08	4	No.8	3.00-5.50	26.4-48.4	800	198	7 51/64	1.20	2.64	20.0	49/64	9.50	3/8	0.50	17.5	44572
US-LT51PB-05	5	No.10	5.00-10.5	44.0-92.4	480	198	7 51/64	1.20	2.64	20.0	49/64	9.50	3/8	0.50	17.5	44582
US-LT60P-11	4-5	No.8-No.10	4.00-7.00	35.2-61.6	1100	230	9 1/16	1.70	3.74	22.0	57/64	9.50	3/8	0.60	21.0	49902
US-LT60P-07	5-6	No.10-1/4	4.00-10.0	35.2-88.0	650	230	9 1/16	1.70	3.74	22.0	57/64	9.50	3/8	0.60	21.0	49932
US-LT60P-03	5-6	No.10-1/4	7.00-20.0	61.6-176	320	230	9 1/16	1.70	3.74	22.0	57/64	9.50	3/8	0.60	21.0	49962

Air Inlet Size : NPT1/4" Hex. Size of Bit : 6.35mm (1/4")



US-LT40B-05C



US-LT40-03C (P)

SPECIFICATIONS

Recommended Air Pressure : 0.5MPa (72psi)

Model	Capacity (Screw Size)		Torque Range		Free Speed (Approx.) min ⁻¹	Overall Length (about)		Weight less Bit (about)		From Center to Outside (about)		Air Hose Size (inside Dia.)		Average Air Consumption		Code
	mm	in	Nm	in-lbs		mm	in	kg	lb	mm	in	mm	in	m ³ /min	ft ³ /min	
US-LT30B-17C	3.5	No.6	0.70-1.50	6.2-13.2	1700	295	11 39/64	0.70	1.54	36.0	1 27/64	6.35	1/4	0.20	7.0	46932
US-LT30B-11C	4	No.8	1.10-2.10	9.7-18.5	1100	295	11 39/64	0.70	1.54	36.0	1 27/64	6.35	1/4	0.20	7.0	46952
US-LT40B-15C	2.6	No.3	1.00-2.20	8.8-19.4	1500	314	12 25/32	0.90	1.98	36.0	1 27/64	6.35	1/4	0.30	10.5	46152
US-LT40B-08C	3	No.5	1.60-4.00	14.1-35.2	800	314	12 25/32	0.90	1.98	36.0	1 27/64	6.35	1/4	0.30	10.5	46162
US-LT40B-05C	3	No.5	2.30-5.70	20.2-50.2	500	325	13 7/32	0.95	2.09	38.5	1 33/64	6.35	1/4	0.30	10.5	46132
US-LT40-08C(P)	3.5	No.6	1.60-4.00	14.1-35.2	800	314	12 25/32	0.90	1.98	32.0	1 17/64	6.35	1/4	0.30	10.5	46192
US-LT40-05C(P)	4	No.8	2.30-5.70	20.2-50.2	500	325	13 7/32	0.95	2.09	35.5	1 25/64	6.35	1/4	0.30	10.5	46182
US-LT40-03C(P)	4	No.8	5.00-10.0	44-88	300	359	14 11/64	1.10	2.42	35.5	1 25/64	6.35	1/4	0.30	10.5	46172

Air Inlet Size : NPT1/4" Hex. Size of Bit : 6.35mm (1/4") for B-Type Sq. Size of Anvil : 6.35mm (1/4") for US-LT40 Series

OPTION

US-LT20-40 Series Optional Parts



Silencer Assembly

Detachable Silencer Assembly to minimize noise can be attached for more comfortable working environment.

- US-LT20 Series 455-088-2
- US-LT30 Series 408-088-2
- US-LT40 Series 496-088-1



Handle Jacket

Rubber Handle Jacket is available as an optional accessory for operator's comfort.

- US-LT20 470-083-9
- US-LT30 471-083-7
- US-LT40 496-083-0

CUSHION CLUTCH TYPE SCREWDRIVERS



US-4



US-5PB



US-40

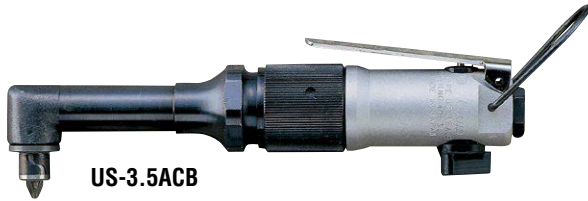

US-3.5ACB



US-5CA

FEATURES

The output torque can be adjusted by turning the adjusting nut to control spring compression or by changing the suitable spring.



Cutaway view of Magnet type head for US-3.5MA

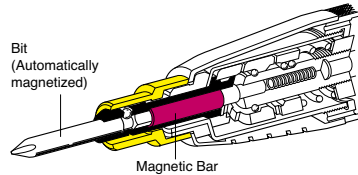

The standard bit contacts the built-in Magnetic Bar to be magnetized and holds the screw.

Head Sizes

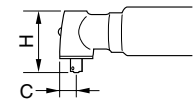

Model	C		H	
	mm	in	mm	in
US-3.5ACB	10.0	25/64	36.5	1 33/64
US-4CA	12.0	15/32	45.0	1 25/32
US-5CA	12.0	15/32	45.0	1 25/32

SPECIFICATIONS

Recommended Air Pressure : 0.4MPa (57psi)

Model	Capacity (Screw Size)		Free Speed (Approx.)	Overall Length (about)		Weight less Socket or Bit (about)		From Center to Outside (about)		Hex. Size of Bit		Air Hose Size		Average Air Consumption		Code
	mm	in		mm	in	kg	lb	mm	in	mm	in	mm	in	m ³ /min	ft ³ /min	
US-3.5A	4	No.8	2000	196	7 23/32	0.60	1.32	17.0	43/64	5.00	13/64	6.35	1/4	0.20	7.0	41012
US-3.5B	4	No.8	2000	214	8 27/64	0.63	1.39	17.0	43/64	6.35	1/4	6.35	1/4	0.20	7.0	41412
US-4	4	No.8	1400	236	9 19/64	0.95	2.09	20.0	25/32	5.00	13/64	6.35	1/4	0.20	7.0	41812
US-5	5	No.10	1400	236	9 19/64	1.10	2.42	21.0	53/64	6.35	1/4	6.35	1/4	0.20	7.0	43012

Air Inlet Size : NPT1/4"

SPECIFICATIONS

Recommended Air Pressure : 0.4MPa (57psi)

Model	Capacity (Screw Size)		Free Speed (Approx.)	Overall Length (about)		Weight less Socket or Bit (about)		From Center to Outside (about)		Hex. Size of Bit		Air Hose Size		Average Air Consumption		Code
	mm	in		mm	in	kg	lb	mm	in	mm	in	mm	in	m ³ /min	ft ³ /min	
US-3.5MA	4	No.8	2000	198	7 51/64	0.65	1.43	17.0	43/64	6.35	1/4	6.35	1/4	0.20	7.0	41112

Air Inlet Size : NPT1/4"

SPECIFICATIONS

Recommended Air Pressure : 0.4MPa (57psi)

Model	Capacity (Screw Size)		Free Speed (Approx.)	Overall Length (about)		Weight less Socket or Bit (about)		From Center to Outside (about)		Hex. Size of Bit		Air Hose Size		Average Air Consumption		Code
	mm	in		mm	in	kg	lb	mm	in	mm	in	mm	in	m ³ /min	ft ³ /min	
US-40	4	No.8	2200	225	8 55/64	0.56	1.23	17.0	43/64	5.00	13/64	6.35	1/4	0.20	7.0	48702
US-50	5	No.10	1200	245	9 41/64	0.90	1.98	18.0	45/64	6.35	1/4	6.35	1/4	0.30	10.7	49612

Air Inlet Size : NPT1/4"

SPECIFICATIONS

Recommended Air Pressure : 0.4MPa (57psi)

Model	Capacity (Screw Size)		Free Speed (Approx.)	Overall Length (about)		Weight Less Bit (about)		From Center to Outside (about)		Air Inlet Size	Hex. Size of Bit		Average Air Consumption		Code
	mm	in		mm	in	kg	lb	mm	in	in	mm	in	m ³ /min	ft ³ /min	
US-3.5PB	4	No.8	2000	200	7 7/8	0.75	1.65	17.0	43/64	NPT1/4	6.35	1/4	0.20	7.0	41712
US-4PB	4	No.8	1400	223	8 25/32	1.15	2.53	20.0	25/32	NPT1/4	5.00	13/64	0.20	7.0	42012
US-5PB	5	No.8	1400	242	9 17/32	1.30	2.86	21.0	33/64	NPT1/4	6.35	1/4	0.20	7.0	43212
* US-3.5ACB	4	No.8	2000	200	7 7/8	0.65	1.43	10.0	25/64	NPT1/4	6.35	1/4	0.20	7.0	41242
US-4CA	4	No.8	1400	225	8 55/64	1.10	2.24	12.0	15/32	NPT1/4	6.35	1/4	0.30	10.7	42212
US-5CA	5	No.10	500	256	10 5/64	1.40	3.08	12.0	15/32	NPT1/4	6.35	1/4	0.30	10.7	43412

*US-3.5ACB is not the cushion clutch type but the direct drive type. Air Hose Size (Inside Diameter) : 6.35mm (1/4")

DIRECT DRIVE SCREWDRIVERS



US-LD50P-17



US-LD40P-21

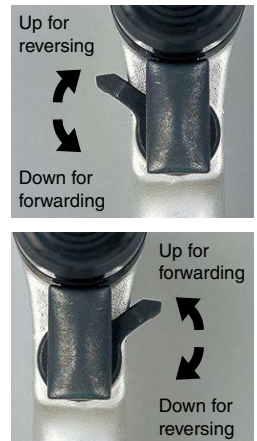

By replacing Reverse Lever, Operator can use either left or right hand.

SCREWDRIVERS

SPECIFICATIONS

Recommended Air Pressure : 0.5MPa (72psi)

Model	Capacity (Screw Size)		Torque Range				Free Speed (about)	Overall Length (about)		Weight Less Bit (about)		From Center to Outside (about)		Average Air Consumption		Code
			Soft Joint		Hard Joint											
	mm	in	Nm	ft-lbs	Nm	ft-lbs	min ⁻¹	mm	in	kg	lb	mm	in	m ³ /min	ft ³ /min	
US-LD40P-21	4	No.8	2.0	1.5	2.8	2.1	2350	130	5 1/8	0.70	1.54	17.0	43/64	0.35	12.3	42522
US-LD40P-15	4	No.8	3.0	2.2	3.2	2.4	1600	130	5 1/8	0.70	1.54	17.0	43/64	0.35	12.3	42532
US-LD40P-08	5	No.10	4.8	3.6	5.7	4.2	850	130	5 1/8	0.70	1.54	17.0	43/64	0.35	12.3	42542
US-LD50P-17	4	No.8	3.5	2.6	5.9	4.4	1800	153	6 1/32	0.90	2.01	20.0	49/64	0.45	15.8	42622
US-LD50P-08	5	No.10	6.5	4.8	7.8	5.8	850	153	6 1/32	0.90	2.01	20.0	49/64	0.45	15.8	42632
US-LD50P-05	5	No.10	10.0	7.4	11.2	8.3	470	153	6 1/32	0.90	2.01	20.0	49/64	0.45	15.8	42642

Air Inlet Size : NPT1/4" Air Hose Size : 6.35mm (1/4") Hex.Size of Bit : 6.35mm (1/4")

IMPACT SCREWDRIVERS

Small, light-weight, and high power. Operators' fatigue can be reduced thanks to discontinuous drive which has less torque reaction.



US-350W



US-450WB



US-5W



US-6W



US-45W

SPECIFICATIONS (STRAIGHT TYPE)

Model	Capacity (Screw Size)		Free Speed (Approx.) min ⁻¹	Overall Length (about)		Weight Less Bit (about)		From Center to Outside (about)		Hex. Size of Bit		Air Hose Size (inside Dia)		Average Air Consumption		Recommended Air Pressure		Code
	mm	in		mm	in	kg	lb	mm	in	mm	in	mm	in	m ³ /min	ft ³ /min	Mpa	psi	
US-350W	4	No.8	14000	168	6 39/64	0.40	0.88	17.0	43/64	6.35	1/4	6.35	1/4	0.20	7.0	0.4	57	40952
US-450WB	5	No.10	11000	161	6 5/16	0.55	1.21	18.5	47/64	6.35	1/4	6.35	1/4	0.20	7.0	0.4	57	43832
US-45W	5	No.10	12000	183	7 13/64	0.50	1.10	17.0	43/64	6.35	1/4	6.35	1/4	0.20	7.0	0.4	57	44612
US-5W	5	No.10	9500	198	7 51/64	0.80	1.60	20.0	27/32	6.35	1/4	6.35	1/4	0.20	7.0	0.4	57	43912
US-6W	6	1/4	9500	187	7 23/64	0.80	1.76	22.5	57/64	6.35	1/4	6.35	1/4	0.30	10.5	0.4	57	47612

Air Inlet Size : NPT1/4"



US-350PW



US-450PW



US-5PW



US-6PW



US-652PW

SPECIFICATIONS (PISTOL TYPE)

Model	Capacity (Screw Size)		Free Speed (Approx.) min ⁻¹	Overall Length (about)		Weight Less Bit (about)		From Center to Outside (about)		Hex. Size of Bit		Air Hose Size (inside Dia)		Average Air Consumption		Recommended Air Pressure		Code
	mm	in		mm	in	kg	lb	mm	in	mm	in	mm	in	m ³ /min	ft ³ /min	Mpa	psi	
US-350PW	4	No.8	15000	121	4 49/64	0.53	1.16	17.0	43/64	6.35	1/4	6.35	1/4	0.20	7.0	0.4	57	40972
US-450PW	5	No.10	14000	151	5 15/16	0.75	1.65	17.0	43/64	6.35	1/4	6.35	1/4	0.20	7.0	0.4	57	45302
US-5PW	5	No.10	9500	168	6 39/64	0.95	2.10	20.0	25/32	6.35	1/4	6.35	1/4	0.30	10.5	0.4	57	44012
US-6PW	6	1/4	9500	170	6 11/16	1.00	2.20	23.0	57/64	6.35	1/4	6.35	1/4	0.30	10.5	0.4	57	47662
US-652PW	6	1/4	9000	155	6 7/64	0.85	1.87	23.0	15/16	6.35	1/4	6.35	1/4	0.35	12.4	0.5	72	48082

Air Inlet Size : NPT1/4"

ABRASIVE TOOLS

GRINDERS

SANDERS

POLISHERS

DIE GRINDERS



UG-38N



UG-25NA



UG-38NL



UG-38NA

Self-Locking Lever attachment

To prevent accidental start of motor.



SPECIFICATIONS

Recommended Air Pressure : 0.6MPa (85psi)

Model	Collet Chuck Size		Max.Free Speed (about)	Rated Horse Power	Overall Length (about)		Weight less wheel (about)		Air Inlet Thread (Pipe Tap)	Air Hose Size		Average Air Consumption		Code	
	mm	in			mm	in	kg	lb		in	mm	in	m ³ /min	ft ³ /min	6mm
UG-25NA	6	1/4	23500	210	152	5 63/64	0.51	1.12	NPT1/4	9.5	3/8	0.3	10.7	50062	50072
G-38EB	6	1/4	20000	315	160	6 19/64	0.58	1.28	NPT1/4	9.5	3/8	0.4	14.0	50442	50452
UG-38N	6	1/4	25000	315	163	6 27/64	0.57	1.25	NPT1/4	9.5	3/8	0.4	14.0	50512	50412
UG-38NA	6	1/4	22000	315	164	6 29/64	0.63	1.39	NPT1/4	9.5	3/8	0.4	14.0	50562	50552
UG-38NL	6	1/4	21000	315	316	12 7/16	0.93	2.05	NPT1/4	9.5	3/8	0.4	14.0	50712	50722
UG-50S-200	6	1/4	23000	195	198	7 51/64	0.60	1.32	NPT1/4	9.5	3/8	0.4	14.0	50842	50852

* Please never mount Grinding Wheel whose diameter is 50mm and larger.

COLLET CHUCKS

G-38EB & UG-50S-200

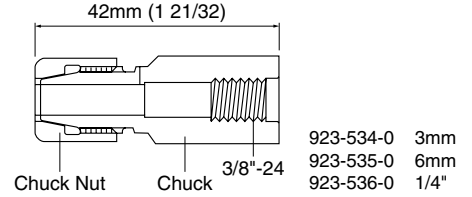

UG-38NSA



UG-38NS

SPECIFICATIONS

Recommended Air Pressure : 0.6MPa (85psi)

Model	Collet Chuck Size		Max.Free Speed (about)	Rated Horse Power	Overall Length (about)		Weight less wheel (about)		Air Inlet Thread (Pipe Tap)	Air Hose Size		Average Air Consumption		Code	
	mm	in			mm	in	kg	lb		in	mm	in	m ³ /min	ft ³ /min	6mm
UG-25NSA	6	1/4	23500	210	150	5 29/32	0.58	1.28	NPT1/4	9.5	3/8	0.3	10.7	50162	50152
UG-38NS	6	1/4	25000	315	173	6 13/16	0.59	1.30	NPT1/4	9.5	3/8	0.4	14.0	50612	50662
UG-38NSA	6	1/4	22000	315	174	6 27/32	0.64	1.41	NPT1/4	9.5	3/8	0.4	14.0	50702	-
UG-38NSL	6	1/4	21000	315	327	12 7/8	0.94	2.07	NPT1/4	9.5	3/8	0.4	14.0	50762	50782

* Please never mount Grinding Wheel whose diameter is 50mm and larger.

COLLET CHUCKS

UG-25N Series

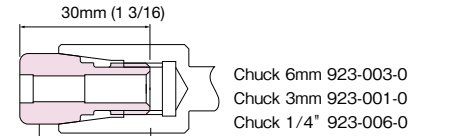

UG-38N Series Chuck Assembly (Chuck+Chuck Nut)

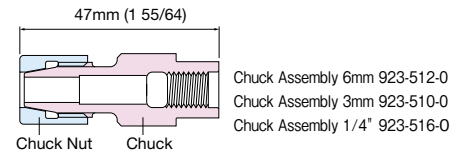

UG-45H



UMG-450

SPECIFICATIONS

Recommended Air Pressure : 0.6MPa (85psi)

Model	Collet Chuck Size		Max.Free Speed (about)	Rated Horse Power	Overall Length (about)		Weight less wheel (about)		Air Inlet Thread (Pipe Tap)	Air Hose Size		Average Air Consumption		Code
	mm	in			mm	in	kg	lb		in	mm	in	m ³ /min	
UMG-450	3	No.5	43000	37	144	5 43/64	0.80	1.76	NPT1/8	4.8	3/16	0.3	10.7	58712
UG-45H	6	1/4	18000	375	196	7 23/62	0.75	1.65	NPT1/4	9.5	3/8	0.6	22.0	51632

* Please never mount Grinding Wheel whose diameter is 50mm and larger.



Fasten the collet chuck firmly to avoid loosening of the cutting tool.

COLLET CHUCKS

UG-45H

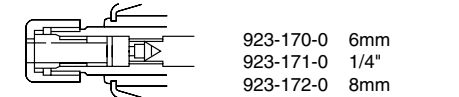

SPECIFICATIONS

Recommended Air Pressure : 0.6MPa (85psi)

Model	Collet Chuck Size		Max.Free Speed (about)	Rated Horse Power	Overall Length (about)		Weight less wheel (about)		Air Inlet Thread (Pipe Tap)	Air Hose Size		Average Air Consumption		Code
	mm	in			mm	in	kg	lb		in	mm	in	m ³ /min	
UG-50S-200A	6	1/4	20000	195	195	7 45/64	0.90	1.98	NPT1/4	9.5	3/8	0.4	14.0	50862

* Please never mount Grinding Wheel whose diameter is 50mm and larger.

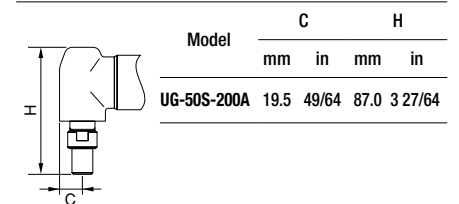

GRINDERS



UG-65E



UG-650E

Collet chucks of 6mm and 1/4" capacity are available as optional accessories for mandrel mounted abrasives, cutters and files.

	6mm	1/4"
UNF3/8-24	923-530-0	923-532-0
W3/8-16	923-523-0	923-526-0

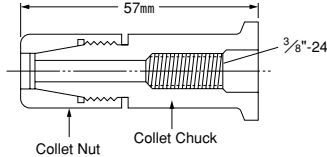

SPECIFICATIONS

Recommended Air Pressure : 0.6MPa (85psi)

Type	Model	Throttle Handle	Capacity (Wheel Size)		Max.Free Speed (about)	Rated Horse Power	Overall Length (about)		Weight less wheel (about)		Air Inlet Thread (Pipe Tap)	Air Hose Size		Average Air Consumption		Code
			mm	in			mm	in	kg	lb		mm	in	m ³ /min	ft ³ /min	
Standard	UG-65E	Sleeve	63.5	2 1/2	14600	412	242	9 27/32	1.25	2.75	NPT1/4	9.5	3/8	0.6	22	50912
	UG-65ER	Self-closing	63.5	2 1/2	14600	412	271	10 43/64	1.50	3.30	NPT1/4	9.5	3/8	0.6	22	50902
	UG-65EL	Lever	63.5	2 1/2	14600	412	272	10 23/32	1.40	3.08	NPT1/4	9.5	3/8	0.6	22	50922
Rear Exhaust	UG-65EB	Sleeve	63.5	2 1/2	*14600	412	242	9 27/32	1.25	2.75	NPT1/4	9.5	3/8	0.6	22	50962
	UG-65EBR	Self-closing	63.5	2 1/2	*14600	412	271	10 43/64	1.50	3.30	NPT1/4	9.5	3/8	0.6	22	50972
	UG-65EBL	Lever	63.5	2 1/2	*14600	412	272	10 23/32	1.40	3.08	NPT1/4	9.5	3/8	0.6	22	50982
Extended	UG-650E	Sleeve	63.5	2 1/2	14600	412	390	15 23/64	1.72	3.78	NPT1/4	9.5	3/8	0.6	22	50942
	UG-650ER	Self-closing	63.5	2 1/2	14600	412	419	16 1/2	1.97	4.33	NPT1/4	9.5	3/8	0.6	22	50932
	UG-650EL	Lever	63.5	2 1/2	14600	412	420	16 17/32	1.55	3.41	NPT1/4	9.5	3/8	0.6	22	51132

* Speed without silencer



USG-4S



AG-50L



AG-100S

"OUT" type
3/8"-24 Spindle with large FLANGE

"IN" type
URYU special Spindle with small FLANGE

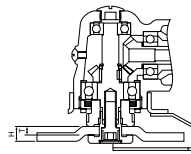
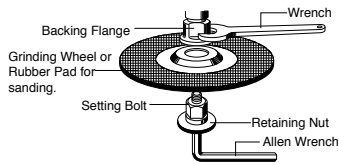
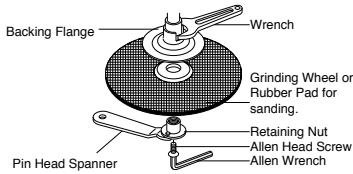

WHEEL SIZE

Model	Thickness	Height
AG-50 Series	3-5mm	9mm
AG-100 Series	4-6mm	10mm
USG-4S	4-6mm	10mm
USG-7S	6-8mm	13mm
USG-L180D	6-8mm	13mm

SPECIFICATIONS

Recommended Air Pressure : 0.6MPa (85psi)

Model	Capacity (Wheel Size)		Max.Free Speed (about)	Rated Horse Power	Overall Length (about)		Overall Height (about)		Weight less wheel (about)		Type of Spindle	Air Inlet Thread (Pipe Tap)	Air Hose Size		Average Air Consumption		Code
	mm	in			mm	in	mm	in	kg	lb			mm	in	m ³ /min	ft ³ /min	
AG-50(OUT)	50	2	15000	337	147	5 25/32	54	2 1/2	0.63	1.40	OUT	NPT1/4	9.5	3/8	0.45	16.0	53622
AG-50L(OUT)	50	2	15000	337	140	5 34/64	54	2 1/2	0.63	1.40	OUT	NPT1/4	9.5	3/8	0.45	16.0	53632
AG-100L(IN)	100	4	13500	315	179	7 3/64	68	2 43/64	1.05	2.30	IN	NPT1/4	9.5	3/8	0.50	18.0	53932
AG-100L(OUT)	100	4	13500	315	179	7 3/64	68	2 43/64	1.05	2.30	OUT	NPT1/4	9.5	3/8	0.50	18.0	53972
AG-100S(IN)	100	4	13500	315	175	6 57/64	68	2 43/64	1.00	2.20	IN	NPT1/4	9.5	3/8	0.50	18.0	53902
AG-100SL(IN)	100	4	13500	315	179	7 3/64	68	2 43/64	1.10	2.40	IN	NPT1/4	9.5	3/8	0.50	18.0	53912
AG-100S(OUT)	100	4	13500	315	179	7 3/64	68	2 43/64	1.00	2.20	OUT	NPT1/4	9.5	3/8	0.50	18.0	53942
AG-100SL(OUT)	100	4	13500	315	179	7 3/64	68	2 43/64	1.10	2.40	OUT	NPT1/4	9.5	3/8	0.50	18.0	53952
USG-4S	100	4	13500	450	236	9 19/64	94	3 45/64	1.65	3.60	IN	NPT1/4	9.5	3/8	0.60	22.0	55462
USG-7S	180	7	7600	962	296	11 21/32	120	4 47/54	3.00	6.60	IN	NPT3/8	12.7	1/2	1.30	46.0	57312
USG-L180D	180	7	7600	888	267	9 1/2	92	3 5/8	2.70	5.90	IN	NPT3/8	12.7	1/2	1.00	36.0	54452

VERTICAL GRINDERS



UVG-2300SL-59



UVG-1800SL-84



USG-4VL



USG-5VLA

Paint color of the actual product may be different from the images.

100mm(4") & 125mm(5") Type

USG series * These gear-less vertical grinders of simple non-governed design offer powerful and trouble free operation.

180mm(7") & 230mm(9") Type

UVG series * Non-friction speed control governor incorporated with over-speed sensing device. This special governor contributes to power compensation also especially when grinding resistance gets strong causing slow speed.
 * Three different speeds are available for UVG-1800.
 * UVG-2300 series is equipped with Dual and Consecutive action Speed Piston Valve for smooth valve opening.

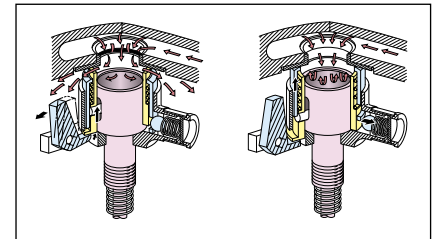

UVG SERIES

NON-FRICTION SPEED CONTROL GOVERNOR incorporated in OVERSPEED SENSING DEVICE

SPECIFICATIONS

Recommended Air Pressure : 0.6MPa (85psi)

Model	Capacity (Wheel Size)		Max.Free Speed (about)	Rated Horse Power	Overall Length (about)		Overall Height (about)		Weight less wheel (about)		Type of Spindle	Air Inlet Thread (Pipe Tap)		Air Hose Size		Average Air Consumption		Code
	mm	in			mm	in	mm	in	kg	lb		in	mm	in	m ³ /min	ft ³ /min		
USG-4VL	100	4	12000	435	220	8 21/32	97	3 13/16	1.40	3.09	IN	NPT1/4	9.5	3/8	0.85	30.0	55862	
USG-5VLA	125	5	10500	375	220	8 21/32	97	3 13/16	1.48	3.26	IN	NPT1/4	9.5	3/8	0.85	30.0	55922	
UVG-1500SL-76	180	7	7600	1200	-	-	162	6 3/8	3.30	7.26	OUT	NPT3/8	12.7	1/2	1.40	49.0	52282	
UVG-1500SL-84	180	7	8400	1200	-	-	162	6 3/8	3.30	7.26	OUT	NPT3/8	12.7	1/2	1.40	49.0	52272	
UVG-1800SL-76	180	7	7600	1650	-	-	175	6 7/8	4.00	8.80	OUT	NPT3/8	12.7	1/2	2.00	70.0	51962	
UVG-1800SL-84	180	7	8400	1650	-	-	175	6 7/8	4.00	8.80	OUT	NPT3/8	12.7	1/2	2.00	70.0	51952	
UVG-2300SL-59	230	9	5900	2550	-	-	182	7 5/32	4.80	10.56	OUT	NPT1/2	19.0	3/4	2.50	80.0	51862	

ANGLE GRINDERS



UAG-50SBL-120



UAG-40SBL-136



UAG-70SBL-76



UAG-90SBL-59

LOCK BUTTON

Push the spring-loaded Lock Button to release the Throttle Lever for operation. When released the Lever is locked automatically.

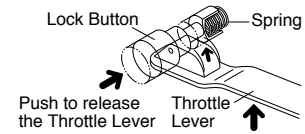

ROLL TYPE THROTTLE HANDLE



UAG-○○SB series
UAG-○○SC series

100mm-230mm(4"-9") Wheel Dia.

URYU offers UAG-series Angle Grinders of 100mm(4"), 125mm(5"), 180mm(7") and 230mm(9") capacity. These governed lightweight and compact grinders deliver high power to weight ratio and feature.

- Non-friction Speed Governor for most efficient grinding performance.
- Unique spring-loaded Exhaust Valve for noise-less trouble free operation.
- Vibration absorbent Dead Handle for less Operator fatigue.

"B" type

Spindle with large Flange

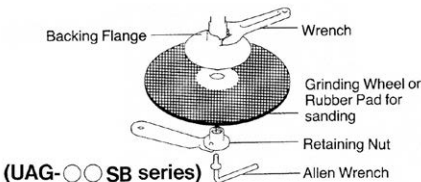

(UAG-○○SB series)

"C" type

URYU unique Spindle with small Flange

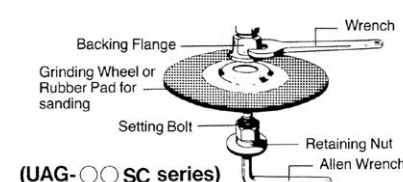

(UAG-○○SC series)

Spring-loaded EXHAUST VALVE

This exhaust hole is kept closed off-operation but is opened upon triggering. This unique exhaust valve features:

- Cutting exhaust noise especially when air is shut off.
- Preventing foreign matters inhalation into the tool.



SPECIFICATIONS

Recommended Air Pressure : 0.6MPa (85psi)

Model	Capacity (Wheel Size)		Max.Free Speed (about) min ⁻¹	Rated Horse Power w	Overall Length (about)		Overall Height (about)		Weight less wheel (about)		Type of Spindle	Air Inlet Thread (Pipe Tap) in	Air Hose Size		Average Air Consumption		Code
	mm	in			mm	in	mm	in	kg	lb			mm	in	m ³ /min	ft ³ /min	
UAG-40SB-136	100	4	13600	712	208	8 3/16	76	3	1.5	3.3	OUT	NPT1/4	9.5	3/8	0.95	34.0	59622
UAG-40SBL-136	100	4	13600	712	246	9 11/16	76	3	1.3	2.9	OUT	NPT1/4	9.5	3/8	0.95	34.0	59632
UAG-40SC-136	100	4	13600	712	208	8 3/16	76	3	1.5	3.3	IN	NPT1/4	9.5	3/8	0.95	34.0	59662
UAG-40SCL-136	100	4	13600	712	246	9 11/16	76	3	1.3	2.9	IN	NPT1/4	9.5	3/8	0.95	34.0	59672
UAG-50SBL-120	125	5	12000	712	246	9 11/16	76	3	1.4	3.1	OUT	NPT1/4	9.5	3/8	0.95	34.0	59702
UAG-50SCL-120	125	5	12000	712	246	9 11/16	76	3	1.4	3.1	IN	NPT1/4	9.5	3/8	0.95	34.0	59752
UAG-50SC-120	125	5	12000	712	208	8 3/16	76	3	1.6	3.5	IN	NPT1/4	9.5	3/8	0.95	34.0	59802
UAG-50SB-109	125	5	10900	712	208	8 3/16	76	3	1.6	3.5	OUT	NPT1/4	9.5	3/8	0.95	34.0	59722
UAG-50SBL-109	125	5	10900	712	246	9 11/16	76	3	1.4	3.1	OUT	NPT1/4	9.5	3/8	0.95	34.0	59732
UAG-70SBL-76	180	7	7600	1500	300	11 13/16	98	3 55/64	2.9	6.4	OUT	NPT3/8	12.7	1/2	1.60	57.0	59132
UAG-70SB-76	180	7	7600	1500	253	10	98	3 55/64	3.0	6.6	OUT	NPT3/8	12.7	1/2	1.60	57.0	59122
UAG-70SC-76	180	7	7600	1500	253	10	87	3 27/64	3.0	6.6	IN	NPT3/8	12.7	1/2	1.60	57.0	59162
UAG-70SCL-76	180	7	7600	1500	300	11 13/16	87	3 27/64	2.8	6.2	IN	NPT3/8	12.7	1/2	1.60	57.0	59172
UAG-90SBL-59	230	9	5900	1875	308	12 1/8	98	3 55/64	3.3	7.3	OUT	NPT3/8	12.7	1/2	1.90	67.0	59332

HORIZONTAL GRINDERS



UG-1250L-72



UG-1250-72



UG-1500L-60



UG-1500-60

Heavy-Duty Type (Governed)

- Two speeds are available for UG-1500 series. (Higher speed for resinoid wheels and lower speed for vitrified wheels)
- Two different Throttle Handles are available for every model.
- Lever Type Handles are recommended for safer operation.

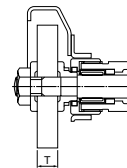

WHEEL SIZE

Model Name	Thickness
UG-1250 Series	13-19mm
UG-1500 Series	18-25mm

SPECIFICATIONS

Recommended Air Pressure : 0.6MPa (85psi)

Model	Capacity (Wheel Size)		Max.Free Speed (about)	Rated Horse Power	Overall Length (about)		Weight less wheel (about)		Spindle Size	Air Inlet Thread (Pipe Tap)	Air Hose Size		Average Air Consumption		Code
	mm	in			min ⁻¹	w	mm	in			kg	lb	in	in	
UG-1250-72	125	5	7200	750	436	17 11/64	3.20	7.04	1/2-13	NPT3/8	12.7	1/2	0.90	32.7	54204
UG-1250L-72	125	5	7200	750	436	17 11/64	2.80	6.16	1/2-13	NPT3/8	12.7	1/2	0.90	32.7	54234
UG-1500-60	150	6	6000	1320	497	19 9/16	4.88	10.74	5/8-11	NPT3/8	12.7	1/2	1.30	45.9	54304
UG-1500-41	150	6	4100	975	497	19 9/16	4.88	10.74	5/8-11	NPT3/8	12.7	1/2	1.30	45.9	54314
UG-1500L-60	150	6	6000	1320	495	19 31/64	4.62	10.16	5/8-11	NPT3/8	12.7	1/2	1.30	45.9	54334
UG-1500L-41	150	6	4100	975	495	19 31/64	4.62	10.16	5/8-11	NPT3/8	12.7	1/2	1.30	45.9	54344

* Do not use vitrified wheels with higher speed type of each model.

SANDERS / POLISHERS



UP-25DB



UP-15



UP-15N



USG-45P



UP-25NB



AG-180W



UP-80-15

Paint color of the actual product may be different from the images.

UP-15N/25NB PAD

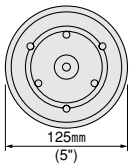

UP-26NB PAD

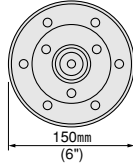

HOLED PAD



Dust collection bag For UP-15N, 25NB&26NB



AG-180W

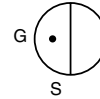

* Two different speeds available: 4,500min⁻¹ for sanding and 7,000min⁻¹ for grinding. AG-180W comes with sanding speed setting 4,500min⁻¹ with relevant accessories as standard. AG-180W can be converted into grinder model by changing speed regulator to G position and mounting wheel guard.

SPECIFICATIONS

Recommended Air Pressure : 0.6MPa (85psi)

Model	Capacity (Pad/Paper Size)		Max.Free Speed (about) min ⁻¹	Rated Horse Power w	Overall Length (about)		Overall Height (about)		Weight less wheel (about)		Spindle Size in	Air Inlet Thread (Pipe Tap) in	Air Hose Size		Average Air Consumption		Code
	mm	in			mm	in	mm	in	kg	lb			mm	in	m ³ /min	ft ³ /min	
USG-45P	125	5	12000	225	187	7 23/64	104	4 3/32	0.87	1.91	3/8-24	NPT1/4	9.5	3/8	0.55	20.0	55372
AG-180W	180	7	7000	690	315	12 13/32	111	4 3/8	2.80	6.16	5/8-11	NPT1/4	9.5	3/8	0.90	32.0	58532
UP-80-15	160	6 3/8	1500	337	-	-	170	6 7/8	1.80	3.96	5/8-11	NPT1/4	9.5	3/8	0.80	28.0	54632
UP-80-40	160	6 3/8	4000	337	-	-	164	6 15/32	1.80	3.96	5/8-11	NPT1/4	9.5	3/8	0.80	28.0	54642
UP-80-60	160	5/16	6000	337	-	-	170	6 7/8	1.80	3.96	5/8-11	NPT1/4	9.5	3/8	0.80	28.0	54672
UP-15	125	5	8500	210	112	4 13/32	93	3 21/32	1.20	2.64	-	NPT1/4	6.35	1/4	0.45	16.0	53812
UP-25DB	125	5	11000	259	238	8 11/32	128	4 3/4	1.70	3.74	-	NPT1/4	6.35	1/4	0.20	7.0	55132
UP-26DB	150	6	11000	259	238	8 11/32	128	4 3/4	1.78	3.92	-	NPT1/4	6.35	1/4	0.20	7.0	55182
UP-15N	125	5	9000	225	175	6 57/64	103	4 1/16	1.50	3.30	-	NPT1/4	6.35	1/4	0.45	16.0	53862
UP-25NB	125	5	9000	300	250	9 23/64	119	4 23/32	1.77	3.90	-	NPT1/4	9.5	3/8	0.60	21.0	54782
UP-26NB	150	6	9000	300	263	10 23/64	119	4 23/32	1.95	4.30	-	NPT1/4	9.5	3/8	0.60	21.0	54792

FEATURES

Features of Dual Action Orbital Sander UP-15, UP-25DB/26DB, UP-25NB/26NB

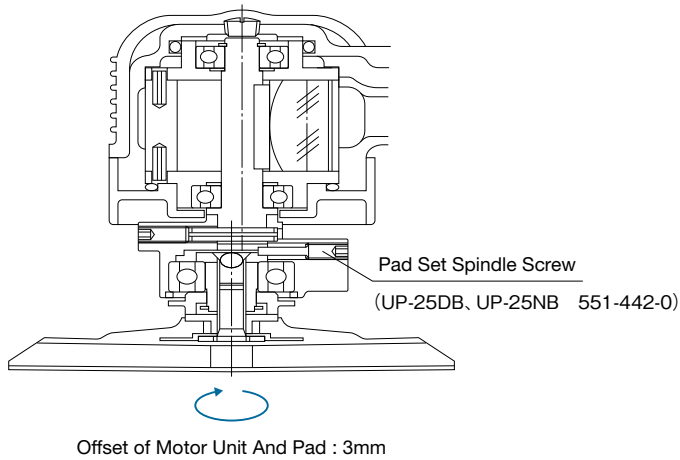

Dual action type (Dual rotation movement) adopted. As the whole surface of paper attached rubber pad is rotated in ellipse and true circle, smooth finish without sanding scratch is possible.

Movement of Single Point on Rubber Pad

(Without Pad Set Spindle Screw)

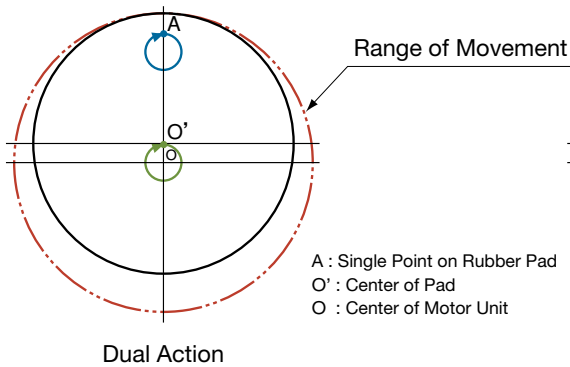

(With Pad Set Spindle Screw)

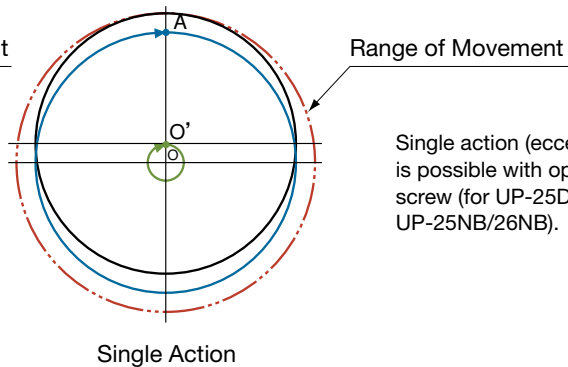

Single action (eccentric movement only) is possible with optional pad set spindle screw (for UP-25DB/26DB, UP-25NB/26NB).

Self-Suction Type Dual Action Orbital Sander (UP-25NB/26NB)

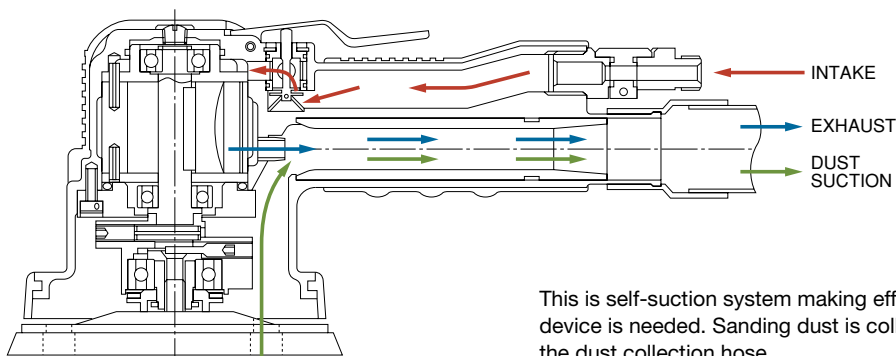

This is self-suction system making effective use of exhaust. No forced suction device is needed. Sanding dust is collected in the dust collection bag, through the dust collection hose.

Backing Pad Assembly for UP-25/UP-26 Series

Name	Dimension					Part Number	Model
	A (mm)	B (mm)	C (mm)	D (mm)	E		
Backing Pad Assembly (5")	124	31.5	20.5	11	NPT1/4	551-409-2	UP-25DB
Backing Pad Assembly (6")	149	30	19	11	NPT1/4	548-409-5	UP-26DB
Backing Pad Assembly (5")	124	28	16.5	11.5	NPT1/4	548-409-3	UP-25NB
Backing Pad Assembly (6")	149	30	19	11	NPT1/4	548-409-5	UP-26NB

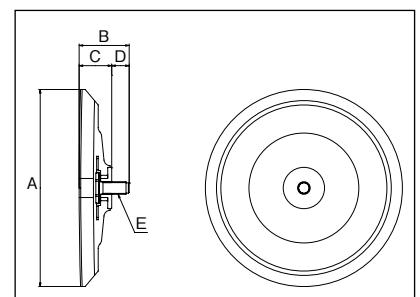

WARNING FOR SAFETY USE

Firstly, follow your local safety regulations strictly on grinders and abrasives. Following are basically required.

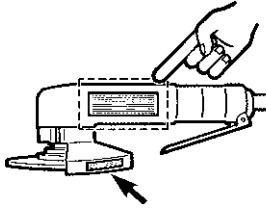

1. Before mounting to the Grinder, make sure that the Grinding Wheels or other Abrasives are of suitable size, shape, quality and strength to the rated speed (min^{-1}) stamped on the name plate or tool housing.

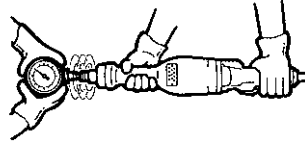

2. The Wheel Spindle speed should be regularly checked with a tachometer to make sure whether normal speed is maintained. The governed Grinders must be checked to be sure governor mechanism is functioning properly.

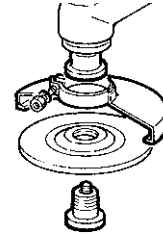

3. Make sure before operation that the Abrasive Wheel should be mounted carefully and sufficiently with flanges and nuts of proper size and shape by use of the Spanners.

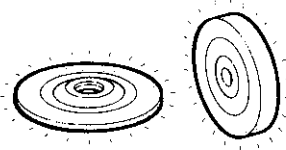

4. All Grinding Wheels should be closely inspected before installation and use. If cracks, nicks, or chips are found, do not use the Wheel in question.

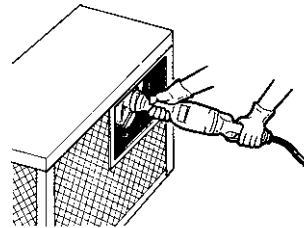

5. Before installing a Grinding Wheel, after all Grinders repair and whenever the Grinder is issued for use, test run the Grinder by a competent person for one minute under a protected area.

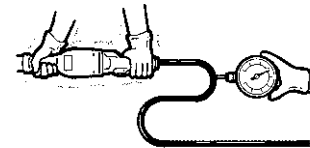

6. Pay attention so that the speed of Grinder does not exceed its maximum speed specified. Do not increase air pressure for power-up.

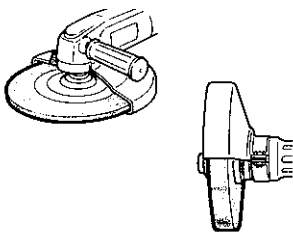

7. Make sure to use wheel guard of suitable size and fix it properly when using Grinding Wheels of more than 50mm in diameter.

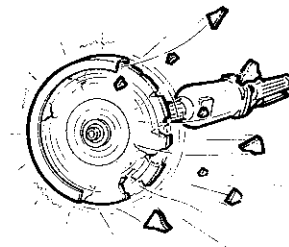

8. Never exceed maximum speed of the Abrasive Wheel to avoid dangerous breakage. Fragments from the Wheel can cause serious injury or death. Do not operate without wearing eye protector and gloves.

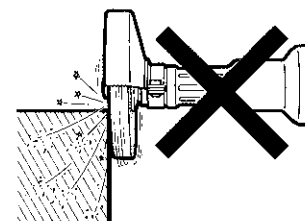

9. Never use the side of grinding Wheel, when a Grinding Wheel is not intentionally designed for side use.

DRILLS & TAPPERS

COMBINATION DRILLS

TAPPERS

DRILLS



UD-50-45

Power is controlled by the built-in Air Regulator located on the handle.
(Pistol handle type only)



UD-50-22



UD-60-29



UD-60-04



UD-80-12

SPECIFICATIONS

Recommended Air Pressure : 0.6MPa (85psi)

Model	Drilling Capacity		Free Speed (about)	Overall Length (about)		Weight with Chuck (about)		From Center to Outside (about)		Nominal Chuck Size		Type of Spindle	Average Air Consumption		Code
	mm	in		mm	in	kg	lb	mm	in	mm	in		in-thr'd	m ³ /min	
UD-50-200	3	No.5	23000	135	5 5/16	0.70	1.50	21.0	53/64	8	5/16	3/8-24UNF	0.40	14	61172
UD-50-45	6	1/4	5000	145	5 23/32	0.86	1.89	21.0	53/64	8	5/16	3/8-24UNF	0.40	14	61142
UD-50-22	8	5/16	2200	140	5 1/2	0.90	1.98	21.0	53/64	8	5/16	3/8-24UNF	0.40	14	61102
UD-60-29	8	5/16	2900	165	6 1/2	1.10	2.43	22.5	57/64	8	5/16	3/8-24UNF	0.50	18	61252
UD-60-20	8	5/16	2000	180	7 1/8	1.20	2.64	22.5	57/64	8	5/16	3/8-24UNF	0.50	18	61242
UD-60-15	8	5/16	1600	180	7 1/8	1.20	2.64	22.5	57/64	8	5/16	3/8-24UNF	0.50	18	61232
UD-60-07	13	1/2	700	219	8 5/8	1.40	3.08	22.5	57/64	13	1/2	1/2-20UNF	0.50	18	61212
UD-60-04	13	1/2	500	220	8 5/8	1.40	3.08	22.5	57/64	13	1/2	1/2-20UNF	0.50	18	61202
UD-80-12	13	1/2	1200	216	8 1/2	1.80	3.96	26.0	1 1/64	13	1/2	1/2-20UNF	0.65	23	61372
UD-80-07	13	1/2	700	239	9 13/32	2.30	5.06	26.0	1 1/64	13	1/2	1/2-20UNF	0.65	23	61342
UD-80-04	16	5/8	400	247	9 23/32	2.90	6.39	26.0	1 1/64	16	5/8	5/8-16UN	0.65	23	61302

*Air Hose Size (Inside Diameter) : 9.5mm (3/8") *Air Inlet Thread : NPT1/4"



UD-50S-45



UD-50S-22



UD-60S-29



UD-60S-04



UD-80S-12

SPECIFICATIONS

Recommended Air Pressure : 0.6MPa (85psi)

Model	Drilling Capacity		Free Speed (about)	Overall Length (about)		Weight with Chuck (about)		From Center to Outside (about)		Nominal Chuck Size		Type of Spindle	Average Air Consumption		Code
	mm	in		mm	in	kg	lb	mm	in	mm	in		in-thr'd	m ³ /min	
UD-50S-200	3	No.5	23000	193	7 7/8	0.70	1.50	21.0	53/64	8	5/16	3/8-24UNF	0.40	14	61972
UD-50S-45	6	1/4	5000	210	8 9/32	0.85	1.87	21.0	53/64	8	5/16	3/8-24UNF	0.40	14	61942
UD-50S-22	8	5/16	2200	205	8 1/16	0.83	1.83	21.0	53/64	8	5/16	3/8-24UNF	0.40	14	61902
UD-60S-29	8	5/16	2900	227	8 15/16	1.05	2.32	22.5	57/64	8	5/16	3/8-24UNF	0.50	18	61772
UD-60S-20	8	5/16	2000	238	9 3/8	1.15	2.54	22.5	57/64	8	5/16	3/8-24UNF	0.50	18	61742
UD-60S-15	8	5/16	1600	238	9 3/8	1.15	2.54	22.5	57/64	8	5/16	3/8-24UNF	0.50	18	61732
UD-60S-07	13	1/2	700	272	10 23/32	1.35	2.98	22.5	57/64	13	1/2	1/2-20UNF	0.50	18	61702
UD-60S-04	13	1/2	500	279	10 63/64	1.35	2.98	22.5	57/64	13	1/2	1/2-20UNF	0.50	18	61712
UD-80S-12	13	1/2	1200	277	10 29/32	1.60	3.53	26.0	1 1/64	13	1/2	1/2-20UNF	0.65	23	61392
UD-80S-07	13	1/2	700	300	11 13/16	2.10	4.73	26.0	1 1/64	13	1/2	1/2-20UNF	0.65	23	61352
UD-80S-04	16	5/8	400	307	12 3/32	2.70	5.95	26.0	1 1/64	16	5/8	5/8-16UN	0.65	23	61332
UD-80-12G	13	1/2	1200	282	11 7/64	2.30	5.06	26.0	1 1/64	13	1/2	1/2-20UNF	0.65	23	61382
UD-80-07G	13	1/2	700	305	12 1/64	2.80	6.16	26.0	1 1/64	13	1/2	1/2-20UNF	0.65	23	61362
UD-80-04G	16	5/8	400	313	12 21/64	3.40	7.50	26.0	1 1/64	16	5/8	5/8-16UN	0.65	23	61322

*Air Hose Size (Inside Diameter) : 9.5mm (3/8") *Air Inlet Thread : NPT1/4"



UD-50S-22A



UD-60S-29C

DRILL ADAPTER (for UD-50S Series)

Part Number : 924-015-0

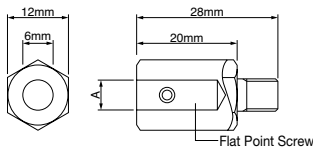

CONE JAW CHUCK (for UD-50S Series)

Capacity : up to 1/4" or 6.35mm

Part Number : 923-100-0

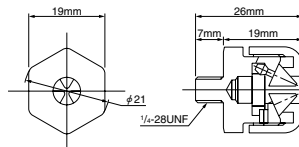

SPECIFICATIONS

Recommended Air Pressure : 0.6MPa (85psi)

Model	Drilling Capacity		Free Speed (about)	Overall Length (about)		Weight with Chuck (about)		Height with Chuck (about)		From Center to Outside (about)		Nominal Chuck Size		Type of Spindle	Average Air Consumption		Code
	mm	in		mm	in	kg	lb	mm	in	mm	in	mm	in		m ³ /min	ft ³ /min	
UD-50S-45A	4	No.8	5000	253	9 31/32	0.90	1.98	40	1 57/64	21.0	53/64	-	-	1/4-28UNF	0.40	14	62042
UD-50S-22A	4	No.8	2200	248	9 49/64	0.88	1.94	40	1 57/64	21.0	53/64	-	-	1/4-28UNF	0.40	14	62002
UD-60S-29C	8	5/16	2900	276	10 55/64	1.52	3.34	90	3 35/64	22.5	57/64	8	5/16	3/8-24UNF	0.50	18	61872
UD-60S-15C	8	5/16	1600	283	11 9/64	1.60	3.52	90	3 35/64	22.5	57/64	8	5/16	3/8-24UNF	0.50	18	61832

*Air Hose Size (Inside Diameter) : 9.5mm (3/8") *Air Inlet Thread : NPT1/4"

OPTION

Dead Handle & Dead Handle Connector



For UD-60 series : 613-720-0 Dead Handle / 612-730-0 Dead Handle Connector
 For UD-80 series : 613-720-0 Dead Handle / 613-730-0 Dead Handle Connector

Head Sizes

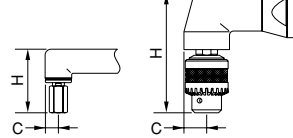

Model	C		H	
	mm	in	mm	in
UD-50S-22A	10.0	25/64	48.0	1 57/64
UD-60S-29C	17.0	43/64	90.0	3 35/64
UD-60S-15C	17.0	43/64	90.0	3 35/64

DRILLS & TAPERS

SELECTION GUIDE

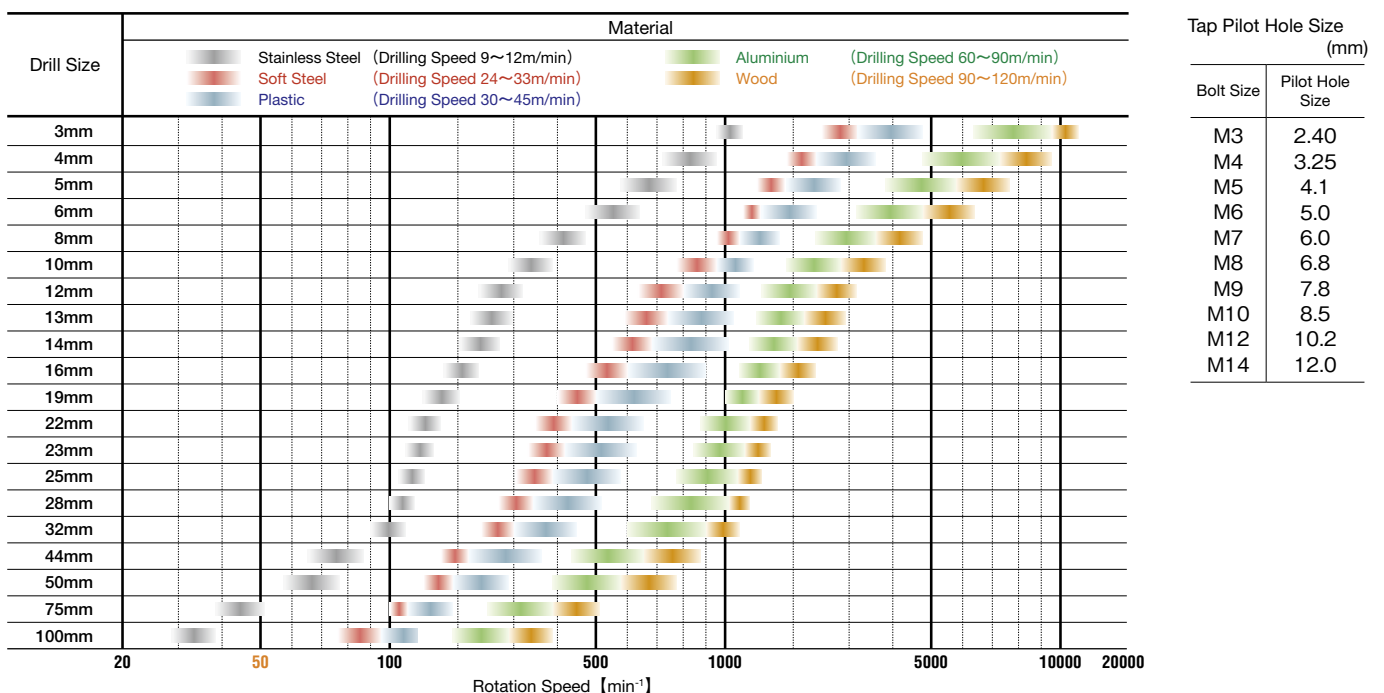

DRILLS



Smooth and accurate operations for many kinds of applications, such as drilling, tapping, reaming and tube rolling, etc.

SELF-RETURNING ROLL TYPE THROTTLE HANDLE

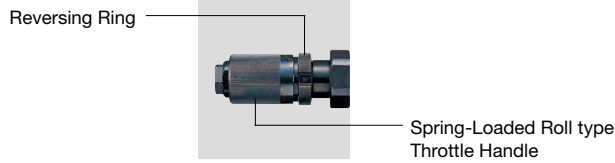

SPECIFICATIONS

Recommended Air Pressure : 0.6MPa(85psi)

Model	Type	Drilling Capacity		Free Speed (about)	Overall Length (about)		Weight (about)		From Center to Outside (about)		Feed Length (about)		Air Hose Size		Average Air Consumption		Code
		mm	in	min ⁻¹	mm	in	kg	lb	mm	in	mm	in	mm	in	m ³ /min	ft ³ /min	
URD-22RR	Self-Returning	22.0	7/8	600	442	17 13/32	5.8	12.8	39	1 17/32	70	2 3/4	12.7	1/2	1.3	46	63242

Air Inlet Thread : NPT3/8" for URD-22RR

TAPPERS

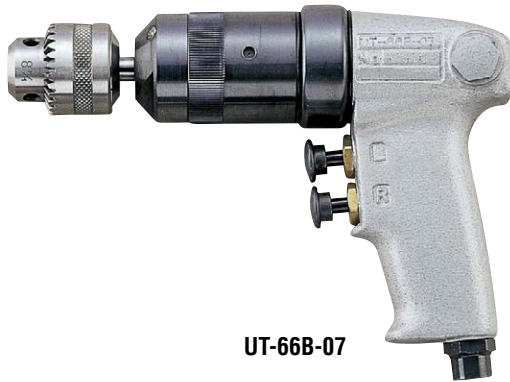

UT-66B-07

Double-Trigger Handle

UT-66 series reversible drills have the double trigger handle for quick and frequent switchover of rotation.

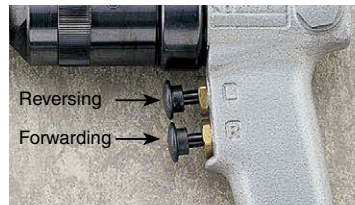

"Push-Pull" Auto Reversing Clutches

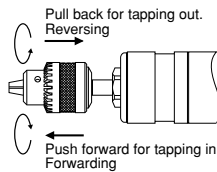

UT-60-04



UT-60S-07

Power is controlled by the built-in Air Regulator located on the handle.
UT-60-07
UT-60-04

OPTION

Size up of Chuck is possible.



923-060-0



923-053-0



682-732-0



678-732-7

Chuck Adaptor

Name	Part Number
φ 13 Chuck	923-060-0
φ 13 Taper Adapter	682-732-0
φ 10 Chuck	923-053-0
φ 10 Taper Adapter	678-732-7

*Tapping capacity is up to nominal Standard chuck size.

SPECIFICATIONS

Recommended Air Pressure : 0.6MPa (85psi)

Model	Tapping Capacity		Free Speed (about)	Overall Length (about)		Weight with Chuck (about)		From Center to Outside (about)		Average Air Consumption		Code
	mm	in	min ⁻¹	mm	in	kg	lb	mm	in	m ³ /min	ft ³ /min	
UT-66B-15	6	1/4	1500	183	7 7/32	1.32	2.90	25.0	31/32	0.4	14.4	68102
UT-66B-07	8	5/16	800	196	7 23/32	1.42	3.12	25.0	31/32	0.4	14.4	68132
UT-60-07	8	5/16	680	244	9 39/64	1.80	3.96	22.5	57/64	0.5	18.0	67852
UT-60-04	8	5/16	400	244	9 39/64	1.80	3.96	22.5	57/64	0.5	18.0	67872
UT-60S-07	8	5/16	680	316	12 7/16	1.65	3.63	22.5	57/64	0.5	18.0	68022
UT-60S-04	8	5/16	400	316	12 7/16	1.65	3.63	22.5	57/64	0.5	18.0	68002

Air Inlet Thread : NPT1/4" for UT-66B-15~UT-60S-04 Air Hose Size : 9.5mm (3/8") for UT-66B-15~UT-60S-04
Nominal Chuck Size : 8mm (5/16") for UT-66B-07~UT-60S-04

PERCUSSION TOOLS

RIVETING HAMMERS

IMPACT CUTTERS

FLUX CHIPPERS

CHIPPING HAMMERS

RIVETING HAMMERS

SUPER VIBRATION-PROOF TYPE

Super vibration-proof hammers reduce vibration exposure stress and fatigue of operators. Total vibration value is less than 2.5m/s².



BRH-1UD



BRH-1USD



BRH-5USD



BRH-5UD

SPECIFICATIONS

Recommended Air Pressure : 0.6MPa (85psi)

Model	Riveting Capacity				Blow Per Min. (about)	Overall Length (about)		Weight Less Rivet Set (about)		Piston Diameter (about)		Piston Stroke (about)		Air Inlet Thread (Pipe Tap)	Air Hose Size		Average Air Consumption		Code										
	Duralumin		Steel												mm	in	kg	lb	mm	in	mm	in	in	mm	in	m ³ /min	ft ³ /min	R	H
	mm	in	mm	in																									
BRH-1UD (R,H)	3.2	No.5	2.4	No.3	2800	143	5 5/8	1.40	3.1	14.30	9/16	38	1 1/2	NPT1/4	9.5	3/8	0.34	12.0	70882	70892									
BRH-5UD (R,H)	6.4	1/4	4.8	No.10	1800	210	8 17/64	1.65	3.6	12.70	1/2	100	4	NPT1/4	9.5	3/8	0.37	13.0	70942	70952									
BRH-1USD (R,H)	3.2	No.5	2.4	No.3	2800	272	10 45/64	1.60	3.5	14.30	9/16	38	1 1/2	NPT1/4	9.5	3/8	0.34	12.0	70922	70932									
BRH-5USD (R,H)	6.4	1/4	4.8	No.10	1800	340	13 25/64	1.90	4.2	12.70	1/2	100	4	NPT1/4	9.5	3/8	0.37	13.0	70982	70992									

STANDARD TYPE

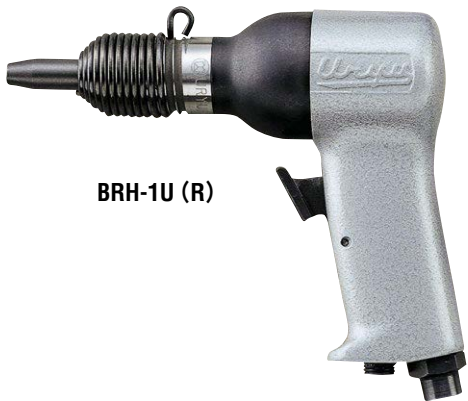

BRH-1U (R)



SBH-0



SBH-1A (R)



BRH-5U (R)



BRH-1US (R)

SPECIFICATIONS

Recommended Air Pressure : 0.6MPa (85psi)

Model	Riveting Capacity				Blow Per Min. (about)	Overall Length (about)		Weight Less Rivet Set (about)		Piston Diameter (about)		Piston Stroke (about)		Air Inlet Thread (Pipe Tap)	Air Hose Size		Average Air Consumption		Code										
	Duralumin		Steel												mm	in	kg	lb	mm	in	mm	in	in	mm	in	m ³ /min	ft ³ /min	R	H
	mm	in	mm	in																									
SBH-0	2.3	No.2	-	-	6500	123	4 27/32	0.32	0.7	10.00	25/64	23	29/32	NPT1/8	6.35	1/4	0.10	3.5	70012	-									
SBH-1A(R,H)	2.6	No.3	-	-	4000	209	8 15/64	0.86	1.9	11.11	7/16	45	1 49/64	NPT1/4	6.35	1/4	0.15	5.0	70112	78412									
BRH-1U(R,H)	3.2	No.5	2.4	No.3	2800	122	4 15/16	1.05	2.4	14.30	9/16	38	1 1/2	NPT1/4	9.5	3/8	0.34	12.0	70512	78612									
BRH-1US(R,H)	3.2	No.5	2.4	No.3	2800	180	7 1/8	1.00	2.2	14.30	9/16	38	1 1/2	NPT1/4	9.5	3/8	0.34	12.0	70612	78712									
BRH-1UG(R,H)	3.2	No.5	2.4	No.3	2800	187	7 3/8	1.78	3.9	14.30	9/16	38	1 1/2	NPT1/4	9.5	3/8	0.34	12.0	70712	78812									
BRH-5U(R,H)	6.4	1/4	4.8	No.10	1800	189	7 7/16	1.40	3.1	12.70	1/2	100	4	NPT1/4	9.5	3/8	0.37	13.0	71012	78912									
BRH-5US(R,H)	6.4	1/4	4.8	No.10	1800	246	9 11/16	1.20	2.6	12.70	1/2	100	4	NPT1/4	9.5	3/8	0.37	13.0	71112	79012									
BRH-5UG(R,H)	6.4	1/4	4.8	No.10	1800	258	10 5/32	2.13	4.7	12.70	1/2	100	4	NPT1/4	9.5	3/8	0.37	13.0	71212	79112									

STANDARD ACCESSORIES

Model	Retainer Spring	Rivet Sets
SBH-0	①	a,b
SBH-1A (R)	②、⑥	c,i
BRH-1U (R) series	②、⑥	d,i
BRH-1U (H) series	②、⑥	
BRH-5U (R) series	④、⑥	g,i
BRH-5U (H) series	④、⑥	
BRH-1UD (R) series	②、⑤	d,i
BRH-1UD (H) series	②、⑤	
BRH-5UD (R) series	④、⑤	g,i
BRH-5UD (H) series	④、⑤	

Rivet Set is not attached to the H type.

*Retainer Spring No. ③ and Rivet Set e/f/h are optional accessories.

SHANK SIZE for BRH-5U(H) series BRH-5U(H) series

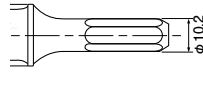

FRONT VIEW OF SPRING CHISEL RETAINER 876-179-1 for BRH-1UD & BRH-5UD series 705-813-1 for BRH-1U & BRH-5U series

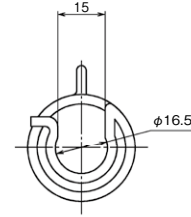

RIVETS for SBH & BRH Series

(mm)

Round Shank	Retainer Spring		Rivet Set		Model	
	Part Number		Part Number			
	①	700-810-1		a	920-810-0	SBH-0
				b	920-004-0	
	②	705-810-1		c	920-020-0	SBH-1A (R) BRH-1U (R) Series BRH-5U (R) Series BRH-1UD (R) Series BRH-5UD (R) Series
				d	920-021-0	
	③	710-811-1		e	920-030-0	
				f	920-032-0	
	④	710-812-1		g	920-040-0	BRH-5U (R) Series BRH-5UD (R) Series
				h	920-042-0	
	⑤	876-179-1		i	920-800-0	BRH-1UD (R) Series BRH-5UD (R) Series
	⑥	705-813-1				SBH-1A (R) BRH-1U (R) Series BRH-5U (R) Series

IMPACT CUTTERS / FLUX CHIPPERS





BRH-7 (R)



UFC-0N

OPTION

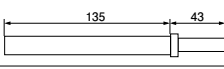
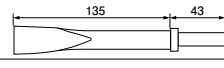
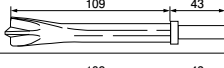
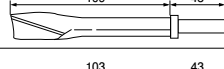
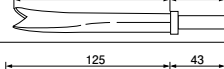
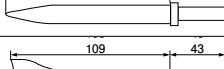
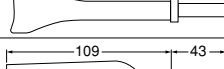
Chisels For BRH-7

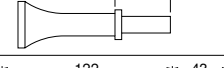
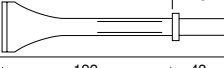
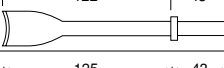
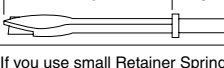
Chisel	Part Number	
	Round Shank	Hex. Shank
 Blank	○ 921-134-0(φ13) * 921-136-0(φ12.7)	○ 921-135-0(φ13) * 921-137-0(φ12.7)
 Flat	○ (7")921-087-0	○ 921-127-0
 Sheet Metal(A)	○ 921-096-0	○ 921-115-0
 Sheet Metal(B)	921-092-0	921-117-0
 Spot Weld Breaker	○ 921-085-0	○ 921-125-0
 Taper Punch	921-091-0	921-121-0
 Bushing Remover	921-094-0	921-119-0
 Fork	921-097-0	921-122-0
 Hammer	921-098-0	921-123-0
 Scraper	○ 921-088-0	○ 921-128-0
 Tail Pipe Cutter	921-093-0	921-118-0
 Double Blade Panel Cutter	921-089-0	921-129-0

*If you use small Retainer Spring 705-810-1, use φ12.7 chisel. Standard Chisels are marked with "○"

Chisels for UFC-0N, 1N

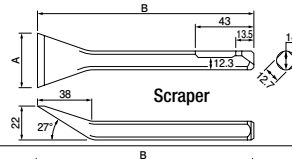
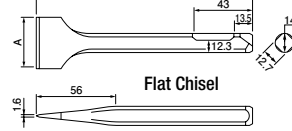

Chisel	Part Number	Dimension(mm)	
		A	B
 Scraper	○ 921-201-0	31.5	150
 Flat Chisel	921-202-0	35	158
	921-206-0	60	140

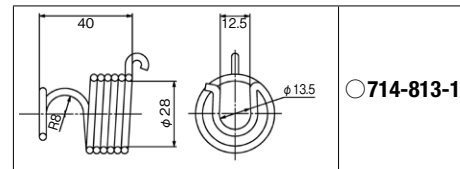
BRH-7 Retainer Spring



○ 714-813-1

Shank Size Of Rivet Sets

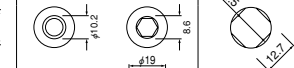
SBH-0	SBH-1A, BRH-1U & 5U	BRH-7	UFC series
			
Round Shank	Hex. Shank	Round Shank	Flux Chippers

SPECIFICATIONS

Recommended Air Pressure : 0.6MPa (85psi)

Model	Blow Per Min. (about)	Overall Length (about)		Weight Less Chisel (about)		Piston Diameter (about)		Piston Stroke (about)		Air Inlet Thread (Pipe Tap)	Air Hose Size		Average Air Consumption		Code
	bpm	mm	in	kg	lb	mm	in	mm	in	in	mm	in	m ³ /min	ft ³ /min	
BRH-7(R)	3400	168	6 39/64	1.64	3.60	19.05	3/4	50	1 31/32	NPT1/4	9.5	3/8	0.48	17.0	71412
BRH-7(H)	3400	168	6 39/64	1.64	3.60	19.05	3/4	50	1 31/32	NPT1/4	9.5	3/8	0.48	17.0	77112
UFC-0N	5300	180	7 1/8	1.38	3.04	25.00	63/64	28	1 1/4	NPT1/4	9.5	3/8	0.3	10.7	75412
UFC-1N	4200	190	7 1/2	1.50	3.30	25.00	63/64	34	1 11/32	NPT1/4	9.5	3/8	0.3	10.7	75712

R= Round Shank H=Hex. Shank BRH-7= with Built-in Air Regulator

CHIPPING HAMMERS

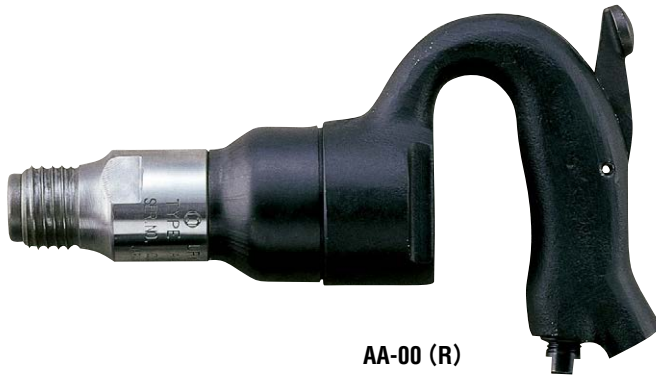

AA-00 (R)

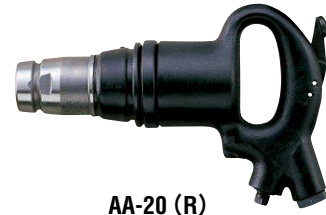

AA-20 (R)



PB-20 (R)

OPTION

CHISELS for AA-00 SERIES (Collared type)

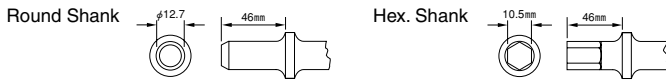

POINT shape	Overall Length		Part Number	
	mm	in	Round Shank	Hex.Shank
	200	7 7/8"	921-224-0	921-049-0
	176	6 15/16"	877-035-1	921-221-0
	220	8 21/32"	921-225-0	921-220-0

CHISELS for AA & PB SERIES

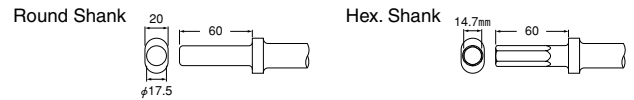

POINT shape	Overall Length		Part Number	
	mm	in	Collared Type	
	200	7 7/8"	R	921-072-0
			H	921-075-0
	220	8 21/32"	R	921-070-0
			H	921-073-0
	200	7 7/8"	R	921-071-0
	220	8 21/32"	H	921-074-0

SPECIFICATIONS

Recommended Air Pressure : 0.6MPa (85psi)

Model	Chisel Shank Size				Blow Per Min. (about)	Overall Length (about)		Weight Less Chisel (about)		Piston Diameter (about)		Piston Stroke (about)		Air Inlet Thread (Pipe Tap)	Air Hose Size		Average Air Consumption		Code	
	Round		Hexagonal			mm	in	kg	lb	mm	in	mm	in		mm	in	m ³ /min	ft ³ /min	R	H
	mm	in	mm	in																
AA-00(R,H)	12.7	1/2	10.5	3/8	2700	228	8 31/32	2.3	5.00	20.0	25/32	50	1 31/32	NPT1/4	9.5	3/8	0.35	12.3	71952	77252
AA-20(R,H)	17.5	5/8	14.7	9/16	2300	270	10 5/8	5.3	11.60	28.0	1 7/64	55	2 5/32	NPT3/8	12.7	1/2	0.60	21.1	72152	77452
AA-30(R,H)	17.5	5/8	14.7	9/16	2000	298	11 23/32	5.7	12.50	28.0	1 7/64	79	3 1/8	NPT3/8	12.7	1/2	0.60	21.1	72252	77552
AA-40(R,H)	17.5	5/8	14.7	9/16	1450	340	13 3/8	6.1	13.40	28.0	1 7/64	111	4 3/8	NPT3/8	12.7	1/2	0.60	21.1	72352	77652
PB-20(R,H)	17.5	5/8	14.7	9/16	1900	350	13 25/32	6.6	14.50	28.5	1 1/8	76	3	NPT3/8	12.7	1/2	0.80	28.0	72752	77852
PB-30(R,H)	17.5	5/8	14.7	9/16	1500	397	15 5/8	7.1	15.60	28.5	1 1/8	102	4 1/62	NPT3/8	12.7	1/2	0.80	28.0	72852	77952

Compressor

Theoretical Consumption Energy of Compressor

You can refer to the table 1 to find the theoretical consumption energy of compressor, which is created through the adiabatic compression, to compress 1m³/min (normal cubic meter per minute) of free air to the various pressure levels. It is highly recommended that you should make the consumption energy value greater than the actual value by taking into consideration the machine efficiency including friction loss caused by compressor.

The consumption energy of compressor providing a pneumatic tool with 1m³/min (normal cubic meter per minute) of air at the gauge pressure 0.6MPa will be some 6.5kW or larger, if we consider the possible losses.

Energy Needed for Compressor

$$Q \geq 6.5 \text{ kW} \times (V \times n + V \times n + V \times n \dots) \times K \times S \times \alpha$$

Q : Energy needed for compressor (kW)

V : Air consumption per tool (m³/min (normal cubic meter per minute))

n : Number of tool

K : Coefficient of multiple tools in operation (table 2)

S : Coefficient of tool usage (table 3)

① Continuous operation: 1.0

Tool model for this category: Grinder, Sander, and Percussion Tool

② Discontinuous operation: 0.5

Tool model for this category: Oil-pulse tool, Impact Wrench, and Screwdriver

α : Loss caused by air leakage from connection between pipes

The table 4 refers to the major compressor power, which is sorted by tool category and model number, to operate a tool based on the catalogue air consumption value.

It takes long for a tool to complete a job at 0.4MPa as a compressor generates less power. On the other hand, it will not take long for a tool to do at 0.6MPa as a compressor generates more power. You should decide which helps you save cost, based on your various applications.

The table 2 gives you an idea of coefficient of operation. The value to operate a number of tools simultaneously is smaller as there are an increasing number of tools in operation.

The air consumption rate refers to the value in which a tool is used continuously for 1 minute. It is recommended, as shown in the table 3, that you should make the consumption energy value smaller than the actual value when you operate tools in the above-mentioned discontinuous operation and that you should make the consumption energy value larger than the actual value when you operate tools in the above-mentioned continuous condition.

Table 1

Gauge pressure	Single Stage Compression (Adiabatic Compression)		
	Theoretical Consumption Energy	Machine Efficiency (15% Included)	Various Losses (30% Included)
MPa	kW	kW	kW
0.3	2.84	3.27	4.25
0.4	3.41	3.92	5.10
0.5	3.91	4.49	5.84
0.6	4.35	5.00	6.50
0.7	4.74	5.45	7.09

Table 2

Number of Tool	Coefficient of Multiple Tools in Operation
1~5	1.0
6~10	0.8
11~20	0.7
21~30	0.6
31~50	0.5
50~100	0.4

Table 3

Operation	Coefficient of Tool Usage
Continuous Operation	1.0
Discontinuous Operation	0.5

Table 4

Category	Tool Model	Air Consumption	Energy Needed for Compressor
		m ³ /min	(kW)
Oil-pulse Tool	UAT60	0.35	2.28
	UL90	0.53	3.45
Impact Wrench	UW-6SLRK	0.35	2.28
	UW-13SRK	0.45	2.93
Screwdriver	US-3.5A	0.20	1.02
	US-5W	0.30	1.53
Grinder	UG-38N	0.40	2.60
	USG-7S	1.10	7.15
Drill	UD-60-29	0.50	3.25
	UD-80-12	0.65	4.23
Percussion Tool	SBH-1A	0.15	0.98
	BRH-7	0.45	2.93

Note: Value for tools except Screwdriver: 0.6MPa at gauge
Value for Screwdriver: 0.4MPa at gauge.

TESTERS & ACCESSORIES

DIGITAL TORQUE TESTERS

TESTERS

ACCESSORIES

DIGITAL TORQUE TESTERS

UDT-200 & UDT-500

UDT-200 & UDT-500 series help you check the performance of oil-pulse tool and hand torque wrench at regular intervals, allowing you to store and download the data.

FEATURES

- The built-in NiMH battery operation gives you hand-carry mobile use in your assembly site especially for pulse-tools' commencement of one day operation. AC power source from your plug can be used together.
- 11-hour continuous operation by battery is possible. Full recharging time is approx. 4-hours.
- Memory function can store maximum 250 torque data.
- Torque check and adjustment for angle nutrunner and shut-off pulse tool using optional soft-joint attachment for traceability.
- Red color LED display gives clear visual confirmation.
- PC output terminal RS-232C is built in the UDT series.
- Torque transducer mounted in pick-up has optimum function to measure oil-pulse tool.



SPECIFICATIONS

Model	Applicable Tool Type	Torque Capacity Range (Recommended Torque Capacity Range)	Blow Capacity Range	Accuracy	Dimensions mm(about) (W × D × H)	Weight Kg(about)	Code (A) (E)	Accessories
UDT-200A (115V) -200E (230V)	Pulse Wrench, Angle Nutrunner (Soft-joint attachment assembly is required to measure shut-off type pulse wrench and angle nutrunner.) Hand torque wrench *Never use impact wrench	3 - 200 Nm (15 - 200 Nm)	0-99 blows (*)	±0.5% at rated output	Amplifier (198 × 171 × 115) Pick-up (245 × 125 × 75)	Amplifier (1.7) Pick-up (8.5)	83102 83112	Socket Adapter (3/8) 836-520-0
								Socket Adaptor (1/2) 836-520-1
								TX-C46E-75 (Socket Bit) 919-700-0
								AC Adaptor (120V) 910-217-0
UDT-500A (115V) -500E (230V)	Pulse Wrench, Angle Nutrunner (Soft-joint attachment assembly is required to measure shut-off type pulse wrench and angle nutrunner.) Hand torque wrench *Never use impact wrench	30 - 500 Nm (150 - 500 Nm)	0-99 blows (*)	±0.5% at rated output	Amplifier (198 × 171 × 115) Pick-up (280 × 150 × 90)	Amplifier (1.7) Pick-up (15.0)	83132 83142	Socket Adapter (1/2) 836-520-7
								Socket Adaptor (5/8) 836-520-8
								Socket Adaptor (3/4) 836-520-9
								AC Adaptor (120V) 910-217-0
								AC Adaptor (230V) 910-218-0

(*) On condition that blow measurements start when input torque exceeds 60% of peak torque. Operating Voltage: 120V for UDT-200A, 220V for UDT-500E. Operating Environment: (10-40°C) Humidity (20-80%), No Dew.

OPTION

Soft-joint Attachment Assembly

UDT-200

For pulse tools or angle nutrunner



(M8) 878-740-1



(M10) 836-890-7



(M12) 836-890-9



(M14) 878-840-1



(M16) 878-800-1



(M18) 878-804-1

For angle nutrunner



(M8) 836-890-1



(M10) 836-890-2



(M12) 836-890-5



(M20) 878-807-1

Choose the correct size for your usage.

Other optional soft-joint attachment assemblies are available. Please contact your nearest URYU distributor.

UDT-25

UDT-25 is designed to check fastening torque and its number of pulses for the small models (e.g. UL30, 40 and UAT30D · 40 · 50) with the torque capacity range 0.3 Nm-25 Nm.

FEATURES

- Compact design for torque measurement and torque display sections gives hand-carry mobile.
- Power source is nickel hydride battery. Full recharging time is approx. 4-hours. 11-hour continuous operation is possible after full charging. *1
- Applicable to reversing torque as well. *2
- UDT-25 tester can be used to check the capacity of US-LT, US-LD, and hand torque wrench as well.
- Red color LED display gives you clear visual confirmation.
- Supreme accuracy of within $\pm 0.5\%$ at the rated output.
- The RS232C port for data output is built in the UDT-25 tester.
- Data storage capacity: 250 data points.



*1: Never use during charging.

*2: Only forward rotation is available for Soft-Joint Attachment.

SPECIFICATIONS

Model	Applicable Tool Type	Torque Capacity Range (Recommended Torque Capacity Range)	Blow Capacity Range	Accuracy	Power Source	Environmental Condition	Dimensions mm (about)	Weight kg (about)	Code	Accessories
UDT-25A (115V)	Pulse Wrench, Torque Control Screwdriver, Direct Drive Screwdriver, Angle Nutrunner, Hand Torque Wrench	0.3 - 25 Nm (2 - 25 Nm)	0 - 99 blows (*)	$\pm 0.5\%$ at rated output	Built-in Nickel Hydride Battery	Operation Temperature: 10 - 40°C (No Dew) Humidity: 20 - 80% (No Dew)	190 (W) × 180 (D) × 59 (H)	2.3	83062	Carrying Case 910-955-0
										AC Adapter (115V) 910-950-0
										AC Adapter (230V) 910-951-0
										Test Socket (3/8") 830-520-6
UDT-25E (230V)	Hexagon Socket Bit (13 × 100)	918-223-0	83072	Driver Adaptor 919-700-0						
				Soft Joint Attachment 830-890-6						
				Soft Joint Attachment 830-890-7						
	Hexagon Head Bolt (M8 × 20)	946-928-0								

(*) On condition that blow measurements start when input torque exceeds 60% of peak torque. Operating Environment : (10-40°C, no freeze) Humidity(20-80%), No Dew

Soft joint Attachments



830-890-6 / For Pulse Tools



830-890-7 / For Screwdrivers

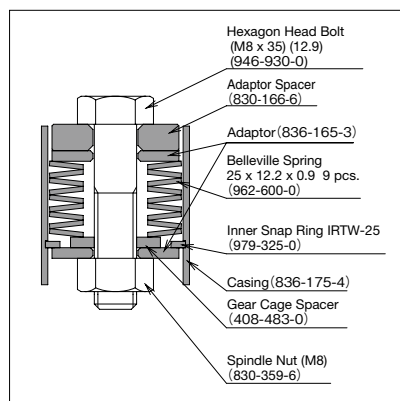
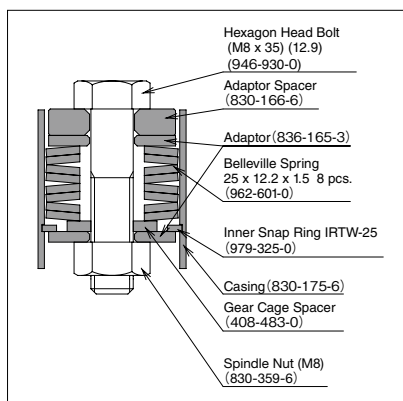

DIGITAL TORQUE TESTERS

UET SERIES

URYU UET-10CUA/10CUE torque tester is designed to check output torque of US-LT series Torque-Control Screwdriver. Its built-in torque sensor shows the torque reading on LED display.



Never use during charging.

FEATURES

- Its built-in torque sensor reads the torque ranging from 0.1 to 10 Nm.
- LED digital display helps you read the reading in the darkness.
- Hit the RESET button for zero point adjustment.
- Supreme accuracy: within $\pm 0.5\%$.
- The CAL diagnostic features help you find any error in the built-in amplifier.
- The portability with a built-in battery helps you check tools on site.
- The soft-joint attachment comes standard with UET-10CU tester, which allows you to simulate the actual application.
- The USB/RS232C port for data output is built in the UET-10CU tester.
- Full recharging time is approx. 2-hours. 16-hour continuous operation is possible after full charging.

SPECIFICATIONS

Model	Applicable Tool Type	Torque Capacity Range (Recommended Torque Capacity Range)	Accuracy	Power Source	Environmental Condition	Dimensions (unit: mm)	Weight (about)	Code	Accessories
UET-10CUA (115V)	US-LT series Torque-Control Screwdriver Small-type Hand Torque Wrench	0.1 - 10 Nm (0.15 - 10 Nm)	$\pm 0.5\%$ at rated output	Built-in Nickel Hydride Battery	Operation Temperature: 0 - 40°C (No Dew) Humidity: 30 - 90% (No Dew)	160 (W) × 190 (D) × 65 (H)	2.3 kg	83932	Carrying Case 909-418-0
AC Adapter (115V) 910-907-0									
UET-10CUE (230V)								83942	AC Adapter (230V) 910-908-0
									Hexagon Socket Bit (13 × 100) (5 Hex) 918-129-0
									Hexagon Socket Bit (13 × 100) (6.35 Hex) 918-223-0
									Driver Attachment Assembly 836-890-4
									Hexagon Head Bolt (M8 × 20) (12.9) (For Hard Joint) 946-928-0
									Plate Spring 25 × 12.2 × 1.5 962-601-0

Driver Attachment Assembly



836-890-4

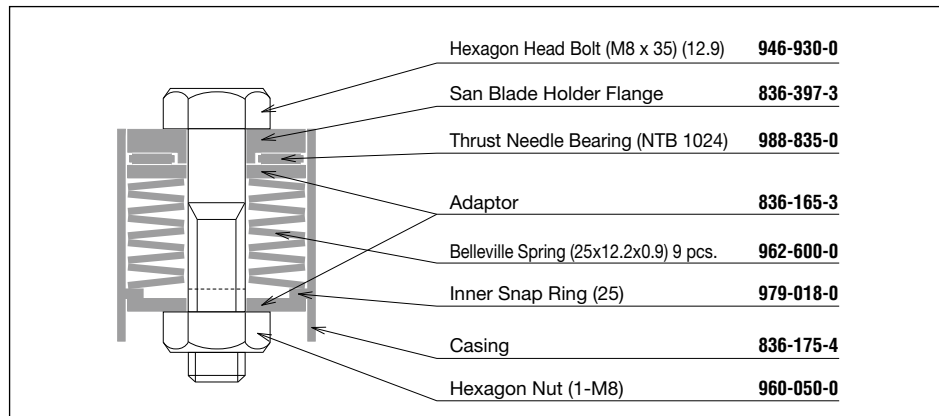

Usage of Testing Attachment

Soft Joint

Typically 3 turns to full torque after the bolt head or nut seats on the surface.

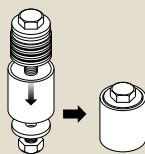

Apply Plate Springs, Testing Bolt (for soft-joint test) Spacer, Nut, and Casing. The Plate Springs are available in both weak and strong tensions.

Hard Joint

Typically 1/10 turn to full torque after the bolt head or nut seats on the surface



Apply Testing Bolt (for heard joint test) and Nut (without Casing, Spacer and Plate Spring).

TESTERS

UFT SERIES HYDRAULIC TESTER

Verify tool's performance with UFT prior to start of daily operation and you will find out less power on tools that can cause under torque troubles during the operation.



UFT-6



UFT-10



UFT-16



UFT-24

FEATURES

- Hard and Soft joint can easily be changed.
- Equipped with digital display.
- Shift between Torque value and tension value can easily be changed.
- Decimal point can also be moved easily.
- Applicable for pulse tools, impact wrenches, angle nutrunner, and any other fastening tools.

SPECIFICATIONS

Model	Bolt Size	Tension Range (kN)	Torque Range (Nm)	Weight (about)		Code	
				Kg	lb	120V	230V
UFT-6	M5	3.6-6.1	3.2-5.4	3.6	7.9	84022	84042
	M6	5.1-13.9	5.4-14.7				
UFT-10	M6	5.1-13.9	5.4-14.7	12.0	26.4	84032	84052
	M8	10.4-22.2	14.7-31.4				
	M10	17.8-30.6	31.4-53.9				

Model	Bolt Size	Tension Range (kN)	Torque Range (Nm)	Weight (about)		Code	
				Kg	lb	120V	230V
UFT-16	M12	25.5-41.7	53.9-88.2	22.0	48.4	84092	84062
	M14	35.7-60.3	88.2-149				
	M16	52.8-67.4	149-190				
UFT-24	M18	59.9-92.6	190-294	50.0	110.0	84082	84072
	M20	83.3-125	294-441				
	M24	104-162	441-686				

*Never provide UFT with torque greater than maximum torque or tension of each bolt size.

UHT SERIES HYDRAULIC TORQUE TESTER

The UHT-series simply designed hydraulic torque testers are suitable to be applied to Screwdrivers (Cushion, Positive, Impact Clutch types), Impact Wrenches and similar Impact action fastening tools in monitoring torque output of new and repaired tools in comparison with their master tools. The readout in the dial indicator does not show absolute torque value, but just comparative degree of power of the tool being tested.



UHT-35

UHT-25

UHT-12



UHT-50

SPECIFICATIONS

Model	Applicable Tool Type or Square Drive Size	Applicable Torque Range		Weight (about)		Code
		Nm	ft-lbs	Kg	lb	
UHT-12	Cushion/Positive Clutch	1-8	0.7-5.9	2.5	5.5	83912
UHT-16	Impact Clutch	3-20	2.2-14.8	7.5	16.5	83812
UHT-25	3/8"(9.5mm)	20-50	14-36	13.0	28.6	84012
UHT-35	1/2"(12.7mm)	50-300	36-215	19.0	41.8	84112
UHT-50	3/4"-1"(19.0-25.4mm)	300-2000	215-1450	150.0	330.0	84212

ACCESSORIES

Air Regulator Assembly

Item	Dimensions			Part Number
	D1	D2	L (mm)	
Air Regulator Assembly 1/8	NPT1/8	NPT1/8	42	932-100-0
Air Regulator Assembly 1/4	NPT1/4	NPT1/4	42	932-110-0

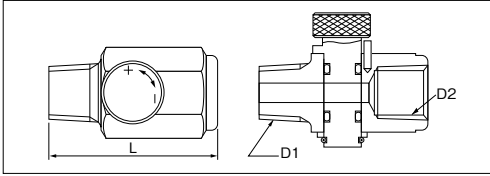

Lock Plug

Item	Dimensions				Part Number
	T	L (mm)	A (mm)	C (mm)	
Lock Plug NPT1/4	NPT1/4	43	14.7	20.3	933-042-0
Lock Plug NPT3/8	NPT3/8	45	16.7	20.3	933-043-0

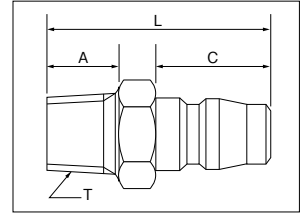

Spanner

Item	Dimensions	Part Number	Used for			
				S (mm)	L (mm)	t (mm)
A	Spanner 8x2x90	8	90	2	936-100-0	UD-50S-22A
	Spanner 17x3.2x135	17	135	3.2	936-051-0	UG-65/650E
	Spanner 21	21	173	5	936-521-0	AG-50, AG-50L
	Spanner 29x4.76x150	29	150	4.76	936-054-0	USG-4S
	Spanner 32x4x150	32	150	4	936-072-0	AG-100S, AG-100SL
B	Spanner 12	12	125	4.5	936-512-0	UD-50S-22A
	Spanner 14	14	145	4.5	936-514-0	UG-25NA, UG-25NSA UG-38N, UG-38NA, UG-38NS, UG-38NSA UG-38NL, UG-38NSL, UG-50S-200A
	Spanner 17	17	159	4	936-517-0	UG-25NA, UG-25NSA UG-65/650E
	Spanner 23x5x195	23	195	5	936-053-0	USG-7S
	Spanner 26x5x195	26	195	5	936-004-0	UP-80-40

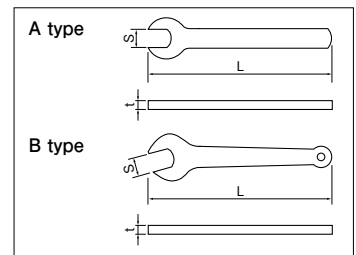

Motor Oil (200mL) 998-725-0



Tool Holders

	Dimension (mm)							Part Number	Used for
	A	B	C	D	E	F	G		
Small	φ34	φ49	φ54	38	60	100	84	852-644-1	UAT30D~70 SERIES, UL30~70 SERIES, US-5PW, -6PW, UD-50-200, -45, -22, UD-60-29, -20, -15, UT-66B-15
Middle	φ36	φ54	φ68	38	66	115	106.5	852-669-1	UAT70~90 SERIES, UL70~90 SERIES, UA40MC~90MC, BP-T40~60 SERIES, UW-6SLRK, -6SBRK, -6SHBRK, -B6SLK, -ST6SHK SERIES
Large	φ50	φ74	φ78	42	80	125	115	852-645-1	UAT90~130 SERIES, UL90~130 SERIES, UA100MC, UW-6SRK, -6SHBRK, -8SHRK, -9SRK SERIES

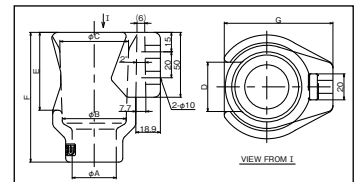

HEXAGONAL SOCKET*

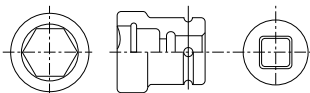

SOCKET FOR STUD-BOLT DRIVING*

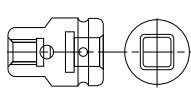

BIT CHUCK ASSEMBLY*

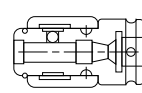

JOINT ASSEMBLY*

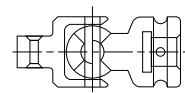

*Please contact your nearest URYU distributor for available sizes.

OPERATOR'S SAFETY MANUAL FOR URYU POWER TOOLS



Safety Instructions

General Safety

- Only qualified and trained operators should install, adjust or use the tool.
- Do not modify the tool. Modifications can reduce the effectiveness of safety measures and increase the risks to the operator.

Work Area Safety

- Keep work area clean and well lit. Cluttered or dark areas invite accidents.
- Do not use the tool in potentially explosive atmospheres, such as in the presence of flammable liquids, gases or dust.
- Always secure workpiece. Use clamps or other practical way to secure and support the workpiece to a stable platform.
- Be aware of slippery surfaces caused by use of the tool and of trip hazards caused by the air line.
- Keep bystanders and visitors away while operating the tool. Distraction can cause you to lose control.

Personal Safety

- Maintain a balanced body position and secure footing. Avoid awkward or off-balanced postures.
- Prevent unintentional or inadvertent start. Ensure that the throttle trigger / lever is in the off-position before connecting the tool to air supply, picking up or carrying the tool. Carry the tool only by the handle. Carrying the tool with your finger on the throttle trigger / lever or energising the tool that has the throttle trigger / lever on invites accidents.
- Dress properly. Do not wear loose clothing, jewellery and neck ware. Keep your hair, clothing and gloves away from all moving parts.
- Use personal protective equipments such as dust mask, non-skid safety shoes and hard hat as instructed by the employer and as required by occupational health and safety regulations.
- Wear suitable gloves to protect hands against hazards such as crushing, impacts, cuts and abrasions and heat.



-Always wear impact-resistant eye protection during the operation of the tool. The grade of protection required should be assessed for each use.

-Remove any adjusting wrench before turning the tool on. A wrench that is left attached to a rotating part of the tool may result in personal injury.

-Ensure that the workpiece is securely fixed.



Noise

-Use hearing protection in accordance with employer's instructions and as required by occupational health and safety regulations. Look after your hearing protection.

-Always ensure that the silencer is in place and in good working order when the tool is operating.

OPERATOR'S SAFETY MANUAL FOR URYU POWER TOOLS

Vibration

- Support the weight of the tool in a stand, tensioner or balancer if possible.
- Hold the tool with a light but safe grip taking account of the required hand reaction forces. The risk from vibration is generally greater when the grip force is higher.
- Wear warm clothing when working in cold conditions and keep your hands warm and dry. Direct cold air away from the hands.
- Use sleeve fittings where practicable.

Dust and Fumes

- Direct the exhaust so as to minimise disturbance of dust in a dust-filled environment. Where dusts or fumes are created, the priority shall be to control them at the point of emission.

Pneumatic Safety

- Do not exceed the maximum air pressure stated on the tool.
- Use correct hoses and always check for damaged or loose hoses and fittings. Whipping hoses can cause severe injury.
- Do not abuse the hose. Never use the hose for carrying, pulling or hanging the tool.
- Keep the hose away from heat, oil, sharp edges or moving parts. Damaged or entangled hoses increase the risk.
- Never direct air at yourself or anyone else.

Electrical Safety

- Do not handle the tool, controller, battery or charger with wet hands.
- Do not expose the tool, controller, battery and charger to rain or wet conditions.
- Do not abuse the power cable. Do not pull the power cable for carrying the tool, controller or charger or disconnecting the power plug from the power point.
- Arrange the power cable so that it may not be stepped, caught or stressed for damages.
- Do not attempt to open, disassemble, modify or service the battery pack.
- Do not crush, puncture, shorten external contacts or circuits, dispose of in fire or water. Keep the battery away from metal objects such as paper clips, coins, keys, screws or other small metal objects that can lead to short circuit.
- Do not expose batteries to temperatures above 40°C.
- Keep the battery and charger dry and away from water or any liquid as it may cause a short circuit.
- Do not use a battery that appears damaged, deformed or discoloured or the one that has any rust on its casing, overheats or emits a foul odour.
- Do not attempt to solder anything to the battery. It will dissolve insulations, destroy the gas exhaust valve or the protection circuit.
- Do not place any object on the charger nor cover the battery with flammable things while charging.
- Leaks from battery cells can occur under extreme conditions. Do not allow the leaking fluid to come in contact with skin or clothing. If already in contact, flush the affected area immediately with clean water and seek medical advice. If the liquid comes in contact with eyes, DO NOT rub; rinse with clean water immediately for minimum 10 minutes and seek medical help. Liquid ejected from the battery may cause irritation or burns.
- Take extra precautions to keep a leaking battery away from fire as there is a danger of ignition or explosion.
- Do not use charger if it is damaged by a drop or is with a damaged power cable.

Residual Risks

- Gloves can become entangled with the rotating drive, causing severed or broken fingers. Rotating drive sockets and drive extensions can easily entangle rubber coated or metal reinforced gloves.
- Additional residual risks may arise when using the tool which may not be included in the safety warnings. These risks can arise from misuse, prolonged use and so on. Even with the application of the relevant safety regulations and the implementation of safety devices, certain residual risks cannot be avoided. (e.g. injuries caused when changing any parts, blades or accessories)

Tool Use and Care

- Hold the tool correctly: be ready to counteract normal or sudden movements – have both hands available.
- Keep the tool dry and clean – free from oil and grease for better control of the tool.
- Do not force the tool. Use the correct tool for your application. The correct tool will do the job better and safer at the rate for which it is designed.
- Check for misalignment or binding of moving parts, breakage of parts and any other condition that may affect the tool operation. If damaged, get the tool repaired before use.
- Select and maintain and replace the socket / bit properly to prevent an unnecessary increase in noise / vibration level(s).
- Check attached tools such as sockets, grinding wheel etc. and replace them if worn or damaged.
- Clean the exhaust silencer and filter frequently or replace in order to prevent clogging and decreased power.
- Store the tool out of the reach of children and do not allow persons unfamiliar with these instructions to operate the tool. Tools are dangerous in the hands of untrained users.

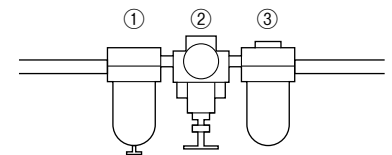
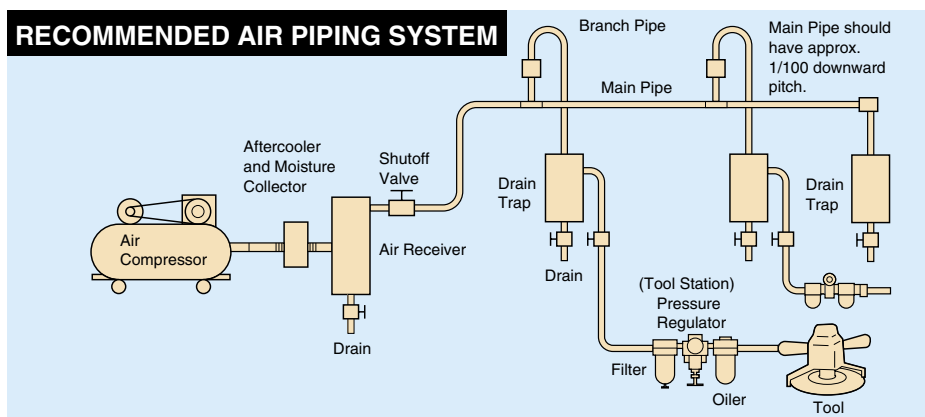

- ① **Air Filter :**
removes water and dirt particles from compressed air.
- ② **Pressure Regulator :**
gives steady and dependable regulation at 0.6MPa (85psi).
- ③ **Air Oiler (Lubricator) :**
assures longer and more dependable tool life.



NOISE & VIBRATION

NOISE LEVELS AND VIBRATION VALUES

On 29 December 2009 EU new Machinery Directive, 2006/42/EC, came into force. Requirements concerning noise and vibration are made more precise. We, URYU SEISAKU, LTD., measured and declare noise levels and vibration emission values in accordance with EU Machinery Directive, 2006/42/EC.

Noise Levels

1) Measurement

Noise Levels are measured in accordance with ISO 15744 for hand-held non-electric power tools and EN62841-1 for electric power tools.

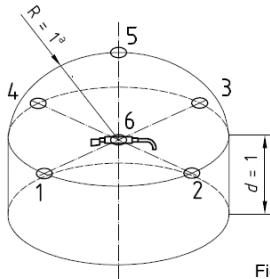

Figure 1 : Microphone Positions

Five microphone positions shall be located 1 m from the geometric centre of the tool. Four positions shall be spaced at regular intervals on a plane defined as passing through the geometric centre of the tool and parallel to the reflecting plane; the fifth position shall be located at a distance of 1 m above the geometric centre of the tool. See the figure 1.

2) Declaration

We declare sound pressure levels (L_p) and sound power level (L_w) in accordance with EU machinery directive, 2006/42/EC. Sound pressure levels are given as numbers when they are 70dB(A) or over. For tools with sound pressure levels lower than 70dB(A), we state < 70dB(A). If the sound pressure level exceeds 80dB(A), we also state the sound power level (L_w) which is 11dB(A) higher than the sound pressure level. To the measured level, 3dB(A) can be added to incorporate variations in production and method. ISO 15744 and EN62841-1 describes how to calculate these figures.

3) Risk Assessment & Risk Management

Noise is part of everyday life, but loud noise can permanently damage your hearing. Once you lose your hearing, you can never get it back. Generally hearing loss is gradual. By the time you notice it, it is probably too late. Manage the risk to exposure to noise at workplace to prevent hearing loss.



- Always use hearing protection in accordance with employer's instructions and as required by occupational health and safety regulations. Look after your hearing protection.
- Ensure that the silencer is in place and in good working order when the tool is operating.

We would recommend 'ISO 9612' for measurement and assessment of exposure to noise in a working environment, for risk assessment.

NOISE LEVELS AND VIBRATION VALUES

Vibration Values

1) Measurement

Vibration is measured according to the relevant part of ISO 28927 series. For some tools that are not covered by ISO 28927 series, ISO 20643 is used to develop a suitable test procedure.

The new Machinery Directive requires vibration total values. A vibration total value is based on a vibration measurement in three directions, x, y and z.

Ex. Measurement Locations for Pistol Grip Type Oil-Pulse Tools

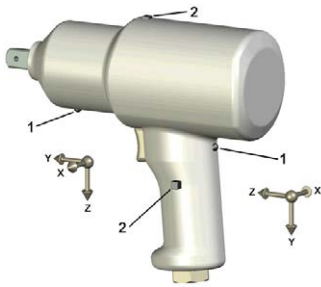

Figure 2 : without Support Handle

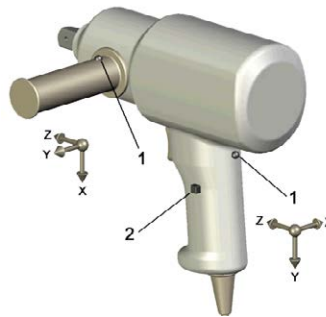

Figure 3: with Support Handle

Oil-pulse tools with a mass less than 2kg are normally operated using only one hand and therefore only the hand position on the trigger handle is measured. Tools of a mass of 2kg or more are normally operated using both hands and measurements are made in two positions. For tools without a side handle, the second hand position is on the front casing or – if that is not possible – on the motor housing (see figure 2). For tools with a side handle, vibrations are measured in three directions both on the trigger and the support handle (see figure 3). On the tools intended to be used with two hands, two positions are measured and the position with the higher value is declared.

The vibration total value (a_{hv}) is the vector sum of the three different directions (a_{hwx} , a_{hwy} & a_{hwz}) at one transducer position. See the equation (1).

$$a_{hv} = \sqrt{a_{hwx}^2 + a_{hwy}^2 + a_{hwz}^2}$$

Equation (1) *See 6 Characterization of vibration, 6.4 Combination of vibration directions.

Three different operators carry out three series of five consecutive measurements on each model, using three different units. Vibration measurement are made in two positions when the tool has mass of 2 kg or over (see figure 2) or when the tool has a support handle (see figure 3). For each hand position, we combine the result from the three operators into one value (\bar{a}_h), using the arithmetic mean of the three \bar{a}_{hv} values. \bar{a}_h values for each hand position are calculated as the arithmetic mean of the \bar{a}_h values for the different tools on that hand position. The declared value, a_{hd} , is the highest of the \bar{a}_h values reported for the two hand positions. The uncertainty K value is estimated by the equation (2).

$$K = 1.5\sigma$$

Equation (2) *See Annex B Determination of uncertainty, B.3 Tests on three machines.

2) Declaration

We declare vibration total values (A_{hd}) and measurement uncertainty (K). Vibration total values are to be given as numbers when they are $2.5m/s^2$ or over. For tools with vibration total values lower than $2.5m/s^2$, we state $< 2.5m/s^2$. Measurement uncertainty K values are given as numbers.

3) Triaxial Vibration Values and Single Direction Vibration Values

There is no fixed relation between triaxial vibration values measured in accordance with ISO 28927 series and one single direction vibration values measured in accordance with ISO 8662 series. Therefore, it is adequate to compare values from the same tool type, referring to the same part of the same standard.

Attention ! ISO 28927-2 is applicable to all hand-held tools for threaded fasteners, but ISO 28927-2 adopts a procedure for testing tools with an impact or impulse mechanism using a test device based on break blocks acting on the outer diameter of a test socket, and a free running test for other type of tools without an impact or impulse mechanism. Therefore, it may not be adequate to compare a value from an oil-pulse tool (under load) and one from a nutrunner without impact or impulse mechanism (free running).

4) Risk Assessment & Risk Management

Using hand-held power tools may cause hand-arm vibration syndrome*1 and carpal tunnel syndrome*2. We recommend risk assessment and regular health checks of the workforce for early symptoms which may relate to vibration exposure to prevent problems developing.

*1: Hand-arm vibration syndrome affects the nerves, blood vessels, muscles and joints of the hand, wrist and arm. It includes vibration white finger, which can cause severe pain in the affected fingers.

*2: Carpal tunnel syndrome is a nerve disorder which may involve pain, tingling, numbness and weakness in parts of the hand, and can be caused by, among other things, exposure to vibration.

- Manage the risk by reducing the exposure to vibrations.
 - Employ work process or a tool which has lower vibrations.
 - Employ work process or a tool which can do the job more quickly.
- Check tools and accessories before using them to make sure that they have been properly maintained and repaired to avoid increased vibration caused by faults or general wear.
- Support the weight of the tool in a stand, tensioner or balancer if possible.
- Avoid gripping or forcing a tool more than you have to. The risk from vibration is generally greater when the grip force is higher.
- Encourage good blood circulation by:
 - keeping your hands warm and dry.
 - massaging and exercising your fingers during work breaks.

We would recommend 'ISO 5349-1' and 'ISO 5349-2' for human exposure to hand-transmitted vibration measurement at workplace, for risk assessment.

Noise & Vibration Emission Values

The declared values were obtained by laboratory type testing in accordance with the stated standards and are suitable for comparison with the declared values of other tools tested in accordance with the same standard. These declared values are not adequate for use in risk assessments. Values measured in individual work places may be higher. The actual exposure values and risk of harm experienced by an individual user are unique and depend upon the way the user works, the workpiece and the workstation design, as well as upon the exposure time and the physical condition of the user.

We, URYU SEISAKU, LTD., cannot be held liable for the consequences of using the declared values, instead of values reflecting the actual exposure, in an individual risk assessment in a work place situation over which we have no control.

NOISE LEVELS AND VIBRATION VALUES

The uncertainty in the sound levels is 3dB (A).

Model	EN62841-1		ISO 28927-2 *measured under load	
	Sound Pressure Level (L _{pa})	Sound Power Level (L _{WA})	Vibration Total Value (A _{ms})	Vibration Uncertainty (K)
	dB(A)	dB(A)	m/sec ²	m/sec ²
Transducerized Battery Pulse Tools				
UBX-AF500Z	< 70	-	< 2.5	0.59
UBX-AF600Z	72	-	< 2.5	0.60
UBX-AF700Z	72	-	< 2.5	0.61
UBX-AF900Z	73	-	< 2.5	0.61
Pistol Grip Battery Pulse Tools				
UBX-T40D	< 70	-	< 2.5	0.61
UBX-T50D	71	-	< 2.5	0.64
UBX-T60D	73	-	< 2.5	0.65
UBX-T50	71	-	< 2.5	0.62
UBX-T60	73	-	< 2.5	0.63
UBX-T70	75	-	< 2.5	0.67
UBX-T80	76	-	< 2.5	0.61
UBX-T40D(RF8)	< 70	-	< 2.5	0.61
UBX-T50D(RF8)	71	-	< 2.5	0.64
UBX-T60D(RF8)	73	-	< 2.5	0.65
UBX-T50(RF8)	71	-	< 2.5	0.62
UBX-T60(RF8)	73	-	< 2.5	0.63
UBX-T70(RF8)	75	-	< 2.5	0.67
UBX-T80(RF8)	76	-	< 2.5	0.61
UBX-T40D(Z)	< 70	-	< 2.5	0.61
UBX-T50D(Z)	71	-	< 2.5	0.64
UBX-T60D(Z)	73	-	< 2.5	0.65
UBX-T50(Z)	71	-	< 2.5	0.62
UBX-T60(Z)	73	-	< 2.5	0.63
UBX-T70(Z)	75	-	< 2.5	0.67
UBX-T80(Z)	76	-	< 2.5	0.61
BP-T40D	< 70	-	< 2.5	0.54
BP-T50D	< 70	-	< 2.5	0.54
BP-T60D	73	-	< 2.5	0.57
BP-T40	< 70	-	< 2.5	0.54
BP-T50	< 70	-	< 2.5	0.54
BP-T60	71	-	< 2.5	0.55
BP-T40D(RF8)	< 70	-	< 2.5	0.54
BP-T50D(RF8)	< 70	-	< 2.5	0.54
BP-T60D(RF8)	73	-	< 2.5	0.57
BP-T40(RF8)	< 70	-	< 2.5	0.54
BP-T50(RF8)	< 70	-	< 2.5	0.54
BP-T60(RF8)	71	-	< 2.5	0.55
BP-T40D(Z)	< 70	-	< 2.5	0.54
BP-T50D(Z)	< 70	-	< 2.5	0.54
BP-T60D(Z)	73	-	< 2.5	0.57
BP-T40(Z)	< 70	-	< 2.5	0.54
BP-T50(Z)	< 70	-	< 2.5	0.54
BP-T60(Z)	71	-	< 2.5	0.55
BP-T40D(TK)	< 70	-	< 2.5	0.54
BP-T50D(TK)	< 70	-	< 2.5	0.54
BP-T60D(TK)	73	-	< 2.5	0.57
BP-T40(TK)	< 70	-	< 2.5	0.54
BP-T50(TK)	< 70	-	< 2.5	0.54
BP-T60(TK)	71	-	< 2.5	0.55
Pistol Grip Electric Pulse Tools				
UCX-AF600L	73	-	< 2.5	0.60
UCX-AF600	74	-	< 2.5	0.61
UCX-AF700	76	-	< 2.5	0.62
UCX-AF900	78	-	< 2.5	0.7
UDP-A600LMC, (TL)	74	-	< 2.5	0.60
UDP-A700MC, (TL)	76	-	< 2.5	0.63
UDP-A100MC, (TL)	76	-	< 2.5	0.63
UDP-A120MC, (TL)	78	-	< 2.5	0.64

The noise measurement method of EN62841-1 is much aligned with ISO15744.

Model	ISO 15744		ISO 28927-2 *measured under load	
	Sound Pressure Level (L _{pa})	Sound Power Level (L _{WA})	Vibration Total Value (A _{ms})	Vibration Uncertainty (K)
	dB(A)	dB(A)	m/sec ²	m/sec ²
Transducerized Pulse Tools				
UA40MC	78	-	< 2.5	0.53
UA40DMC	78	-	< 2.5	0.55
UA50MC	78	-	< 2.5	0.54
UA50DMC	78	-	< 2.5	0.55
UA60MC	80	-	< 2.5	0.54
UA70MC	80	-	< 2.5	0.55
UA80MC	80	-	< 2.5	0.56
UA90MC	82	93	< 2.5	0.58
UA100MC	82	93	< 2.5	0.60
UA130MC	82	93	< 2.5	0.63
UA150MC	83	94	2.7	0.7
UA40SMC	78	-	< 2.5	0.7
UA40SDMC	78	-	2.7	0.7
UA50SMC	78	-	2.7	0.7
UA50SDMC	78	-	3.1	0.7
UA60SMC	80	-	3.1	0.7
UA60SDMC	80	-	3.5	0.8
UA70SMC	80	-	3.4	0.7
UA400AMC	78	-	< 2.5	0.54
UA500AMC	78	-	< 2.5	0.55
UA600AMC	80	-	< 2.5	0.55
UA700AMC	80	-	< 2.5	0.56
UA800AMC	80	-	< 2.5	0.57
UA900AMC	82	93	< 2.5	0.57
UA1000AMC	82	93	< 2.5	0.60
UA1300AMC	82	93	< 2.5	0.60
UXR-1820MC	84	95	< 2.5	0.6
UXR-2000MC	85	96	2.7	0.7
Straight Type Transducerized Pulse Tools				
UXR-2400SMC	85	96	3.8	0.8
Pistol Grip Shut-off Pulse Tools				
UAT30D	76	-	< 2.5	0.58
UAT40	75	-	< 2.5	0.54
UAT50	78	-	< 2.5	0.55
UAT60	80	-	< 2.5	0.58
UAT70	80	-	< 2.5	0.59
UAT80	80	-	< 2.5	0.63
UAT90	82	93	< 2.5	0.6
UAT100	82	93	< 2.5	0.6
UAT130	82	93	2.6	0.7
UAT150	82	93	2.9	0.7
UAT180	84	95	3.2	0.7
UAT200	85	96	2.8	0.7
UAT40D	75	-	< 2.5	0.59
UAT50D	78	-	< 2.5	0.62
UAT60D	80	-	< 2.5	0.7
UAT50L	75	-	< 2.5	0.54
UAT60L	77	-	< 2.5	0.57
UAT70L	78	-	< 2.5	0.59
UAT80L	78	-	< 2.5	0.62
UAT90L	79	-	< 2.5	0.63
UAT100L	79	-	< 2.5	0.6
UAT130L	79	-	< 2.5	0.7
UAT150L	79	-	2.8	0.7
UAT180L	80	-	3.1	0.7
UAT200L	85	96	2.6	0.7
UAT50DL	75	-	< 2.5	0.62
UAT60DL	77	-	< 2.5	0.63
Straight Type Shut-off Pulse Tools				
UAT40S	70	-	< 2.5	0.7
UAT50S	78	-	2.7	0.7
UAT60S	80	-	3.1	0.7
UAT70S	80	-	3.4	0.8
UAT30SD	79	-	< 2.5	0.6
UAT40SD	70	-	2.7	0.7
UAT50SD	78	-	3.1	0.7
UAT60SD	80	-	3.5	0.8
UAT50SL	75	-	2.6	0.7

The uncertainty in the sound levels is 3dB (A).

UAT60SL	77	-	3.0	0.7
UAT70SL	78	-	3.2	0.7
UAT50SDL	75	-	2.9	0.7
UAT60SDL	77	-	3.4	0.8
UXR-T2400S	85	96	4.0	0.8
UXR-T3000S	85	96	4.6	0.9
Angle Head Shut-off Pulse Tools				
ULT40C	70	-	10.3	1.4
ULT50C	78	-	15.4	1.8
ULT60C	80	-	16.5	1.9
ULT70C	82	93	16.7	2.0
ULT70CH	82	93	17.1	2.0
ULT50CL	75	-	13.6	1.7
ULT60CL	78	-	14.8	1.8
ULT70CL	78	-	15.2	1.8
ULT70CHL	78	-	15.6	1.9
Pistol Grip Non Shut-off Pulse Tools				
UL30	75	-	< 2.5	0.56
UL30D	75	-	< 2.5	0.57
UL40	75	-	< 2.5	0.57
UL40D	75	-	< 2.5	0.58
UL50	78	-	< 2.5	0.59
UL50D	78	-	< 2.5	0.62
UL60	80	-	< 2.5	0.60
UL60D	80	-	< 2.5	0.7
UL70	80	-	< 2.5	0.60
UL80	80	-	< 2.5	0.6
UL90	82	93	< 2.5	0.6
UL100	80	-	< 2.5	0.6
UL130	83	94	2.7	0.7
UL150	84	95	3.0	0.7
Straight Type Non Shut-off Pulse Tools				
UL30S	72	-	< 2.5	0.7
UL30SD	75	-	2.5	0.7
UL40S	72	-	2.9	0.7
UL40SD	75	-	3.0	0.7
UL50S	78	-	3.3	0.8
UL50SD	78	-	3.2	0.7
UL60S	80	-	3.5	0.8
UL60SD	80	-	3.7	0.8
UL70S	84	95	3.7	0.8
Pistol Grip Non Shut-Off Pulse Tools				
U-350D	74	-	< 2.5	0.53
UXR-2000	85	96	2.6	0.7
Straight Type Non Shut-Off Pulse Tools				
U-310SD	74	-	< 2.5	0.57
U-350SD	74	-	< 2.5	0.58
UXR-2000S	85	96	3.2	0.7
UXR-2400S	85	96	4.1	0.8
UXR-3000S	85	96	4.7	0.9
Pistol Grip Impact Wrenches				
UW-6SLRK	91	102	3.8	0.8
UW-6SHBRK	92	103	4.3	0.8
UW-B6SLK	92	103	4.2	0.8
UW-6SLRDK	91	102	4.1	0.8
UW-6SHBRDK	91	102	4.6	0.9
UW-B6SLDK	92	103	4.8	0.9
UW-61ERK	91	102	4.0	0.8
UW-101ERK	96	107	5.8	1.0
UW-131ERK	97	108	7.6	1.1
UW-161ER	96	107	6.3	1.0
UW-8SHRK	93	104	5.6	1.0
UW-9SRK	93	104	5.1	0.9
UW-10SHRK	95	106	5.8	1.0
UW-13SRK	95	106	7.7	1.1
UW-140P	93	104	6.3	1.0
UW-140PR	93	104	6.6	1.0
UW-140PL	93	104	6.4	1.0
UW-140PRL	93	104	6.7	1.0
UW-220P	95	106	5.6	1.0
UW-220PL	95	106	5.7	1.0
UW-251P	95	106	5.7	1.0
UW-251PL	95	106	5.8	1.0
UW-022S(SHORT)	103	114	6.0	1.0

UW-022S(LONG)	103	114	5.7	1.0
UW-032S(SHORT)	109	120	6.2	1.0
UW-032S(LONG)	109	120	5.9	1.0
UW-381P	99	110	6.2	1.0
UW-381PL	99	110	6.0	1.0
Straight Type Impact Wrenches				
UW-6SSLRK	90	101	5.3	0.9
UW-6SSRK	90	101	5.0	0.9
UW-6SSHRK	91	102	6.7	1.1
UW-6SSLRDK	90	101	6.0	1.0
UW-6SSRDK	90	101	6.1	1.0
UW-6SSHRDK	91	102	7.0	1.1
UW-9SSRK	95	106	10.7	1.4
UW-13SSK	97	108	12.7	1.6
UW-22S(IN)	103	114	6.5	1.0
UW-22S(SHORT)	103	114	6.6	1.0
UW-22S(LONG)	103	114	6.3	1.0
UW-32SLA(SHORT)	109	120	6.2	1.0
UW-32SLA(LONG)	109	120	5.9	1.0
UW-381	100	111	7.6	1.1
UW-381L	100	111	7.5	1.1
UW-401(SHORT)	110	121	8.9	1.3
UW-401L	110	121	9.0	1.3
Angle Head Impact Wrenches				
UW-6CSLRK	93	104	18.4	2.1
UW-6CSRK	94	105	18.0	2.1
UW-6CSHRK	94	105	27.0	3.0
UW-6ASLRK	92	103	17.8	2.0
UW-9CSRK	95	106	33.0	3
UW-13CSK	97	108	35.0	4
Stud Bolt Impact Wrenches				
UW-ST6SHK	92	103	4.1	0.8
UW-ST9SK	97	108	4.9	0.9
UW-ST10SHK	97	108	5.8	1.0
UW-ST6SSHK	92	103	6.6	1.0
Ratchet Wrenches				
URW-6	81	92	3.2	0.7
URW-60	85	96	3.4	0.8
URW-60R	85	96	3.4	0.8
URW-8N	90	101	3.2	0.7
URW-80	93	104	4.0	0.8
URW-80R	93	104	4.0	0.8
URW-81	93	104	4.0	0.8
URW-81R	93	104	4.0	0.8
URW-8	86	97	3.3	0.8
URW-9N	90	101	3.3	0.7
URW-10N	90	101	3.3	0.8
URW-12N	91	102	3.6	0.8
URW-12NA	91	102	3.6	0.8
URW-12NB	91	102	4.1	0.8
ISO15744				
Model	ISO15744		ISO 28927-2 *measured at free running	
	Sound Pressure Level (L _{PA})	Sound Power Level (L _{WA})	Vibration Total Value (A _{h,v})	Vibration Uncertainty (K)
	dB(A)	dB(A)	m/sec ²	m/sec ²
Open-Ended Wrenches				
UOW-11-10	76	-	< 2.5	0.47
UOW-11-14	76	-	< 2.5	0.47
UOW-11-22	76	-	< 2.5	0.47
UOW-11-30	76	-	< 2.5	0.47
UOW-T60-10	76	-	< 2.5	0.47
UOW-T60-14	76	-	< 2.5	0.47
UOW-T60-22	76	-	< 2.5	0.47
UOW-T60-30	76	-	< 2.5	0.48
Gearred Wrenches				
UGW-6N	76	-	< 2.5	0.48
UGW-8N	76	-	< 2.5	0.48
Angle Nutrunners				
UAN-611R-60C	80	-	< 2.5	0.48
UAN-611R-50C	80	-	< 2.5	0.48
UAN-611R-40C	80	-	< 2.5	0.48
UAN-611R-30C	80	-	< 2.5	0.48
UAN-701R-60C	85	96	< 2.5	0.51

NOISE LEVELS AND VIBRATION VALUES

The uncertainty in the sound levels is 3dB (A).

UAN-701R-40C	85	96	< 2.5	0.50
UAN-701R-30C	85	96	< 2.5	0.50
UAN-611RM-60C	80	-	< 2.5	0.49
UAN-611RM-50C	80	-	< 2.5	0.48
UAN-611RM-40C	80	-	< 2.5	0.48
UAN-611RM-30C	80	-	< 2.5	0.48
UAN-701RM-60C	85	96	< 2.5	0.51
UAN-701RM-40C	85	96	< 2.5	0.50
UAN-701RM-30C	85	96	< 2.5	0.50
Straight Screwdrivers				
US-LT10B	75	-	< 2.5	0.48
US-LT20A(B)-26	71	-	< 2.5	0.48
US-LT20A(B)-18	70	-	< 2.5	0.48
US-LT20A(B)-10	70	-	< 2.5	0.48
US-LT30A(B)-23	71	-	< 2.5	0.48
US-LT30A(B)-17	70	-	< 2.5	0.48
US-LT30A(B)-11	70	-	< 2.5	0.48
US-LT40A(B)-21	74	-	< 2.5	0.48
US-LT40A(B)-15	70	-	< 2.5	0.48
US-LT40A(B)-08	70	-	< 2.5	0.48
US-LT50B-17	75	-	< 2.5	0.48
US-LT50B-08	75	-	< 2.5	0.48
US-LT50B-05	74	-	< 2.5	0.49
US-LT30A(B)L-23	71	-	< 2.5	0.48
US-LT30A(B)L-17	70	-	< 2.5	0.48
US-LT30A(B)L-11	70	-	< 2.5	0.48
US-LT40A(B)L-21	74	-	< 2.5	0.48
US-LT40A(B)L-15	70	-	< 2.5	0.48
US-LT40A(B)L-08	70	-	< 2.5	0.48
Pistol Grip Screwdrivers				
US-LT31PB-23	70	-	< 2.5	0.48
US-LT31PB-17	70	-	< 2.5	0.48
US-LT31PB-11	70	-	< 2.5	0.48
US-LT31PB-05	70	-	< 2.5	0.48
US-LT41PB-21	74	-	< 2.5	0.48
US-LT41PB-15	70	-	< 2.5	0.48
US-LT41PB-08	70	-	< 2.5	0.48
US-LT51PB-17	75	-	< 2.5	0.48
US-LT51PB-08	75	-	< 2.5	0.48
US-LT51PB-05	74	-	< 2.5	0.49
US-LT60P-11	77	-	< 2.5	0.48
US-LT60P-07	76	-	< 2.5	0.49
US-LT60P-03	75	-	< 2.5	0.49
Angle Head Screwdrivers				
US-LT30B-17C	73	-	< 2.5	0.48
US-LT30B-11C	73	-	< 2.5	0.48
US-LT40B-15C	75	-	< 2.5	0.48
US-LT40B-08C	75	-	< 2.5	0.48
US-LT40B-05C	75	-	< 2.5	0.48
US-LT40-08C(P)	75	-	< 2.5	0.48
US-LT40-05C(P)	75	-	< 2.5	0.48
US-LT40-03C(P)	72	-	< 2.5	0.48
Cushion Clutch Type Screwdrivers				
US-3.5A	75	-	< 2.5	0.48
US-3.5B	75	-	< 2.5	0.48
US-4	75	-	< 2.5	0.48
US-5	75	-	< 2.5	0.48
US-3.5MA	75	-	< 2.5	0.48
US-40	70	-	< 2.5	0.48
US-50	76	-	< 2.5	0.48
US-3.5PB	75	-	< 2.5	0.48
US-4PB	75	-	< 2.5	0.48
US-5PB	75	-	< 2.5	0.48
US-4CA	85	96	< 2.5	0.48
US-5CA	85	96	< 2.5	0.48
Direct Drive Screwdrivers				
US-LD40P-21	74	-	< 2.5	0.48
US-LD40P-15	70	-	< 2.5	0.48
US-LD40P-08	70	-	< 2.5	0.48
US-LD50P-17	76	-	< 2.5	0.48
US-LD50P-08	75	-	< 2.5	0.48
US-LD50P-05	75	-	< 2.5	0.49
US-3.5ACB	85	96	< 2.5	0.48

Model	ISO15744		ISO 28927-2 *measured under load	
	Sound Pressure Level (L _{PA})	Sound Power Level (L _{WA})	Vibration Total Value (A _{hd})	Vibration Uncertainty (K)
	dB(A)	dB(A)	m/sec ²	m/sec ²
Impact Screwdrivers				
US-350W	80	-	3.6	0.8
US-450WB	80	-	3.8	0.8
US-45W	80	-	4.0	0.8
US-5W	85	96	4.7	0.9
US-6W	85	96	4.9	0.9
US-350PW	81	92	2.8	0.7
US-450PW	79	-	2.9	0.7
US-5PW	85	96	2.8	0.7
US-6PW	85	96	3.0	0.7
US-652PW	79	-	3.7	0.8

Model	ISO 15744		ISO 28927-12	
	Sound Pressure Level (L _{PA})	Sound Power Level (L _{WA})	Vibration Total Value (A _{hd})	Vibration Uncertainty (K)
	dB(A)	dB(A)	m/sec ²	m/sec ²
Die Grinders				
UG-25NA	82	93	< 2.5	0.60
G-38EB	85	96	< 2.5	0.6
UG-38N	85	96	< 2.5	0.6
UG-38NA	75	-	< 2.5	0.6
UG-38NL	85	96	4.0	0.8
UG-50S-200	73	-	2.6	0.7
UG-25NSA	82	93	< 2.5	0.59
UG-38NS	85	96	< 2.5	0.7
UG-38NSA	75	-	< 2.5	0.7
UG-38NSL	85	96	4.1	0.8
UMG-450	75	-	< 2.5	0.58
UG-45H	76	-	< 2.5	0.63
UG-50S-200A	75	-	2.8	0.7

Model	ISO 15744		ISO 28927-4	
	Sound Pressure Level (L _{PA})	Sound Power Level (L _{WA})	Vibration Total Value (A _{hd})	Vibration Uncertainty (K)
	dB(A)	dB(A)	m/sec ²	m/sec ²
Straight Grinders				
UG-65E	88	99	< 2.5	0.6
UG-65ER	85	96	< 2.5	0.6
UG-65EL	85	96	< 2.5	0.7
UG-65EB	95	106	< 2.5	0.7
UG-65EBR	95	106	< 2.5	0.7
UG-65EBL	95	106	< 2.5	0.7
UG-650E	85	96	< 2.5	0.7
UG-650ER	85	96	2.5	0.7
UG-650EL	85	96	< 2.5	0.7
UG-1250-72	88	99	< 2.5	0.7
UG-1250L-72	88	99	< 2.5	0.7
UG-1500-60	88	99	< 2.5	0.48
UG-1500-41	88	99	< 2.5	0.44
UG-1500L-60	88	99	< 2.5	0.45
UG-1500L-41	88	99	< 2.5	0.41

Model	ISO 15744		ISO 28927-1	
	Sound Pressure Level (L _{PA})	Sound Power Level (L _{WA})	Vibration Total Value (A _{hd})	Vibration Uncertainty (K)
	dB(A)	dB(A)	m/sec ²	m/sec ²
Angle Grinders				
AG-50	80	-	< 2.5	0.7
AG-50L	80	-	< 2.5	0.7
AG-100L	80	-	< 2.5	0.55
AG-100S	80	-	< 2.5	0.51
AG-100SL	80	-	< 2.5	0.52
USG-4S	80	-	3.5	1.1
USG-7S	85	96	4.7	1.4
USG-L180D	85	96	4.6	1.4
Vertical Grinders				
USG-4VL	88	99	< 2.5	0.6

The uncertainty in the sound levels is 3dB (A).

USG-5VLA	88	99	< 2.5	0.7
UVG-1500SL-76	78	-	4.0	1.2
UVG-1500SL-84	78	-	3.9	1.2
UVG-1800SL-76	78	-	4.2	1.3
UVG-1800SL-84	78	-	4.1	1.3
UVG-2300SL-59	82	93	4.1	1.2
Angle Grinders				
UAG-40SB-136	84	95	4.1	1.2
UAG-40SBL-136	84	95	4.1	1.3
UAG-40SC-136	84	95	4.1	1.3
UAG-40SCL-136	84	95	4.1	1.3
UAG-50SBL-120	82	93	4.1	1.2
UAG-50SCL-120	82	93	4.1	1.2
UAG-50SC-120	82	93	4.0	1.2
UAG-50SB-109	82	93	4.0	1.2
UAG-50SBL-109	82	93	4.0	1.2
UAG-70SBL-76	83	94	5.2	1.6
UAG-70SB-76	83	94	5.2	1.6
UAG-70SC-76	83	94	5.2	1.6
UAG-70SCL-76	83	94	5.2	1.6
UAG-90SBL-59	88	99	6.0	1.8

Model	ISO 15744		ISO 28927-3	
	Sound Pressure Level (L _{pa})	Sound Power Level (L _{wa})	Vibration Total Value (A _{hd})	Vibration Uncertainty (K)
	dB(A)	dB(A)	m/sec ²	m/sec ²
Sanders & Polishers				
USG-45P	81	92	< 2.5	0.63
AG-180W	86	97	< 2.5	0.7
UP-80-15	82	93	< 2.5	0.56
UP-80-40	84	95	< 2.5	0.57
UP-80-60	85	96	< 2.5	0.58
UP-15	87	98	6.3	1.0
UP-25DB	73	-	5.5	0.9
UP-26DB	74	-	5.8	1.0
UP-15N	94	105	6.4	1.0
UP-25NB	97	108	5.9	1.0
UP-26NB	98	109	6.0	1.0

Model	ISO 15744		ISO 28927-5	
	Sound Pressure Level (L _{pa})	Sound Power Level (L _{wa})	Vibration Total Value (A _{hd})	Vibration Uncertainty (K)
	dB(A)	dB(A)	m/sec ²	m/sec ²
Pistol-Grip Drills				
UD-50-200	73	-	< 2.5	0.61
UD-50-45	72	-	< 2.5	0.58
UD-50-22	72	-	< 2.5	0.59
UD-60-29	77	-	< 2.5	0.61
UD-60-20	77	-	< 2.5	0.60
UD-60-15	76	-	< 2.5	0.57
UD-60-07	75	-	< 2.5	0.58
UD-60-04	75	-	< 2.5	0.57
UD-80-12	79	-	< 2.5	0.62
UD-80-07	79	-	< 2.5	0.6
UD-80-04	79	-	< 2.5	0.63
Straight Drills				
UD-50S-200	78	-	< 2.5	0.6
UD-50S-45	77	-	< 2.5	0.61
UD-50S-22	77	-	< 2.5	0.61
UD-60S-29	77	-	< 2.5	0.6
UD-60S-20	77	-	< 2.5	0.62
UD-60S-15	77	-	< 2.5	0.61
UD-60S-07	75	-	< 2.5	0.60
UD-60S-04	75	-	< 2.5	0.60
UD-80S-12	79	-	< 2.5	0.6
UD-80S-07	79	-	< 2.5	0.6
UD-80S-04	79	-	< 2.5	0.7
UD-80-12G	79	-	< 2.5	0.60
UD-80-07G	79	-	< 2.5	0.62
UD-80-04G	79	-	< 2.5	0.62
Angle Head Drills				
UD-50S-45A	79	-	< 2.5	0.62
UD-50S-22A	79	-	< 2.5	0.61

UD-60S-29C	79	-	< 2.5	0.6
UD-60S-15C	79	-	< 2.5	0.63

Model	ISO 15744		ISO 28927-10	
	Sound Pressure Level (L _{pa})	Sound Power Level (L _{wa})	Vibration Total Value (A _{hd})	Vibration Uncertainty (K)
	dB(A)	dB(A)	m/sec ²	m/sec ²
Heavy Duty Drills				
URD-22RR	95	106	< 2.5	0.7
Pistol/Straight Super Vibration-Proof Riveting Hammers				
BRH-1UD (R, H)	90	101	< 2.5	0.7
BRH-1USD (R, H)	90	101	< 2.5	0.7
BRH-5UD (R, H)	90	101	< 2.5	0.7
BRH-5USD (R, H)	90	101	< 2.5	0.7
Pistol/Straight Type Riveting Hammers				
SBH-0	90	101	< 2.5	0.6
SBH-1A (R, H)	92	103	4.5	0.9
BRH-1U (R, H)	95	106	7.8	1.1
BRH-1US (R, H)	95	106	7.5	1.1
BRH-1UG (R, H)	95	106	7.5	1.1
BRH-5U (R, H)	95	106	7.6	1.1
BRH-5US (R, H)	95	106	7.4	1.1
BRH-5UG (R, H)	95	106	7.3	1.1
Impact Cutters & Flux Chippers				
BRH-7 (R, H)	100	111	7.5	1.1
UFC-0N	90	101	6.0	1.0
UFC-1N	90	101	5.9	1.0
Chipping & Caulking Hammers				
AA-00 (R,H)	95	106	5.0	0.9
AA-20 (R,H)	100	111	5.6	1.0
AA-30 (R,H)	100	111	6.0	1.0
AA-40 (R,H)	100	111	6.3	1.0
PB-20 (R, H)	100	111	6.6	1.0
PB-30 (R, H)	100	111	7.1	1.1

Model	ISO 15744		ISO 20643	
	Sound Pressure Level (L _{pa})	Sound Power Level (L _{wa})	Vibration Total Value (A _{hd})	Vibration Uncertainty (K)
	dB(A)	dB(A)	m/sec ²	m/sec ²
Tappers				
UT-66B-15	85	96	< 2.5	0.56
UT-66B-07	85	96	< 2.5	0.55
UT-60-07	75	-	< 2.5	0.69
UT-60-04	75	-	< 2.5	0.55
UT-60S-07	75	-	< 2.5	0.59
UT-60S-04	75	-	< 2.5	0.56

CONVERSION TABLE

TORQUE

Unit to be converted	Nm	kgf.cm	kgf.m	in.lbs	ft.lbs
1Nm	-	10.2	0.102	8.8	0.74
1kgf.cm	0.098	-	0.01	0.868	0.072
1kgf.m	9.8	100	-	86.8	7.2
1in.lbs	0.114	1.152	1.16×10^{-2}	-	8.3×10^{-2}
1ft.lbs	1.36	13.83	0.138	12	-

HORSE POWER

Unit to be converted	kw	kgf m/s	PS	HP
kw	1	1.02×10^2	1.36	1.34
kgf m/s	9.8×10^{-5}	1	1.33×10^{-2}	1.32×10^{-2}
PS	0.74	75	1	0.99
HP	0.75	76	1.01	1

FLOW

Unit to be converted	m ³ /s	m ³ /min	l/s	ft ³ /s
m ³ /s	1	60	1.00×10^3	35
m ³ /min	1.67×10^{-2}	1	17	0.59
l/s	1.00×10^{-3}	6.0×10^{-2}	1	3.5×10^{-2}
ft ³ /s	2.8×10^{-2}	1.7	28	1

PRESSURE

Unit to be converted	MPa	Bar	kgf/cm ²	psi
MPa	1	10	10.2	1.44×10^2
Bar	10	1	1.02	14.4
kgf/cm ²	9.8×10^{-2}	0.98	1	14.1
psi	6.9×10^{-2}	6.9×10^{-2}	7.1×10^{-2}	1

WEIGHT

Unit to be converted	kg	lbs
kg	1	2.2
lbs	0.45	1

LENGTH

Unit to be converted	m	in	ft
m	1	39	3.3
in	2.54×10^{-2}	1	8.3×10^{-2}
ft	0.31	12.0	1

INDIVIDUAL CATALOG SHEETS AND PARTS LISTS ARE AVAILABLE FOR FURTHER INFORMATION.

INDEX

Model names of models listed in this catalog are listed in ABC order.

AA-00 (R,H)	75	UAG-40SBL-136	62	UBX-T60D (RF8)	14	UG-650ER	60	US-4	54	USG-L180D	60
AA-20 (R,H)	75	UAG-40SC-136	62	UBX-T60D (Z)	14	UG-1250-72	63	US-4CA	54	UT-60-04	70
AA-30 (R,H)	75	UAG-40SCL-136	62	UBX-T70	13	UG-1250L-72	63	US-4PB	54	UT-60-07	70
AA-40 (R,H)	75	UAG-50SB-109	62	UBX-T70 (RF8)	14	UG-1500-41	63	US-5	54	UT-60S-04	70
AG-50 (OUT)	60	UAG-50SBL-109	62	UBX-T70 (Z)	14	UG-1500-60	63	US-5CA	54	UT-60S-07	70
AG-50L (OUT)	60	UAG-50SBL-120	62	UBX-T80	13	UG-1500L-41	63	US-5PB	54	UT-66B-07	70
AG-100L (IN)	60	UAG-50SC-120	62	UBX-T80 (RF8)	14	UG-1500L-60	63	US-5PW	56	UT-66B-15	70
AG-100L (OUT)	60	UAG-50SCL-120	62	UBX-T80 (Z)	14	UGW-6N	38	US-5W	56	UTM-1500A/E (CN)	46
AG-100S (IN)	60	UAG-70SB-76	62	UCC-100Z	11	UGW-8N	38	US-6PW	56	UTM-1500A/E (PS)	46
AG-100S (OUT)	60	UAG-70SBL-76	62	UCX-AF600	21	UHT-12	81	US-6W	56	UTM-1500A/E (RA-CN)	46
AG-100SL (IN)	60	UAG-70SC-76	62	UCX-AF600L	21	UHT-16	81	US-40	54	UTM-1500A/E (RA-PS)	46
AG-100SL (OUT)	60	UAG-70SCL-76	62	UCX-AF700	21	UHT-25	81	US-45W	56	UVG-1500SL-76	61
AG-180W	64	UAG-90SBL-59	62	UCX-AF900	21	UHT-35	81	US-50	54	UVG-1500SL-84	61
BP-T40	14	UAN-611R-30C	39	UD-50-22	68	UHT-50	81	US-350PW	56	UVG-1800SL-76	61
BP-T40 (RF8)	15	UAN-611R-40C	39	UD-50-45	68	UHT-16	81	US-350W	56	UVG-1800SL-84	61
BP-T40 (TK)	16	UAN-611R-50C	39	UD-50-200	68	UHT-35	81	US-450PW	56	UVG-2300SL-59	61
BP-T40 (Z)	15	UAN-611R-60C	39	UD-50S-22	68	UHT-50	81	US-450WB	56	UW-6ASLRK	43
BP-T40D	14	UAN-611RM-30C	39	UD-50S-22A	69	UL30D	34	US-652PW	56	UW-6CSHRK	43
BP-T40D (RF8)	15	UAN-611RM-40C	39	UD-50S-45	68	UL30S	34	US-LD40P-08	55	UW-6CSLRK	43
BP-T40D (TK)	16	UAN-611RM-50C	39	UD-50S-45A	69	UL40	34	US-LD40P-15	55	UW-6CSRK	43
BP-T40D (Z)	15	UAN-611RM-60C	39	UD-50S-200	68	UL40D	34	US-LD40P-21	55	UW-6SHBRK	42
BP-T50	14	UAN-701R-30C	39	UD-60-04	68	UL40SD	34	US-LD50P-05	55	UW-6SLRK	42
BP-T50 (RF8)	15	UAN-701R-40C	39	UD-60-07	68	UL50	34	US-LD50P-08	55	UW-6SSHRK	43
BP-T50 (TK)	16	UAN-701R-60C	39	UD-60-15	68	UL50D	34	US-LD50P-17	55	UW-6SSLRK	43
BP-T50 (Z)	15	UAN-701RM-30C	39	UD-60-20	68	UL50S	34	US-LT10B	52	UW-6SSRK	43
BP-T50D	14	UAN-701RM-40C	39	UD-60-29	68	UL50SD	34	US-LT20A-10	52	UW-6SHRK	42
BP-T50D (RF8)	15	UAN-701RM-60C	39	UD-60S-04	68	UL60	34	US-LT20A-18	52	UW-9CSRK	43
BP-T50D (TK)	16	UAT30D	33	UD-60S-07	68	UL60D	34	US-LT20A-26	52	UW-9SRK	42
BP-T50D (Z)	15	UAT30SD	33	UD-60S-15	68	UL60S	34	US-LT20B-10	52	UW-9SSRK	43
BP-T60	14	UAT40	33	UD-60S-15C	69	UL60SD	34	US-LT20B-18	52	UW-10SHRK	42
BP-T60 (RF8)	15	UAT40D	33	UD-60S-20	68	UL70	34	US-LT20B-26	52	UW-13CSK	43
BP-T60 (TK)	16	UAT40S	33	UD-60S-29	68	UL70S	34	US-LT30A-11	52	UW-13SRK	42
BP-T60 (Z)	15	UAT40SD	33	UD-60S-29C	69	UL80	34	US-LT30A-17	52	UW-13SSK	43
BP-T60D	14	UAT50	33	UD-80-04	68	UL90	34	US-LT30A-23	52	UW-22S	43
BP-T60D (RF8)	15	UAT50D	33	UD-80-04G	68	UL100	34	US-LT30AL-11	52	UW-22S (L)	43
BP-T60D (TK)	16	UAT50DL	33	UD-80-07	68	UL130	34	US-LT30AL-17	52	UW-32SLA	43
BP-T60D (Z)	15	UAT50L	33	UD-80-07G	68	UL150	34	US-LT30AL-23	52	UW-32SLA (L)	43
BRH-1U (R,H)	72	UAT50S	33	UD-80-12	68	ULT40C	35	US-LT30B-11	52	UW-61ERK	42
BRH-1UD (R,H)	72	UAT50SD	33	UD-80-12G	68	ULT50C	35	US-LT30B-11C	53	UW-75S	45
BRH-1UG (R,H)	72	UAT50SDL	33	UD-80S-04	68	ULT50CL	35	US-LT30B-17	52	UW-75S (1 1/2)	45
BRH-1US (R,H)	72	UAT50SL	33	UD-80S-07	68	ULT60C	35	US-LT30B-17C	53	UW-101ERK	42
BRH-1USD (R,H)	72	UAT60	33	UD-80S-12	68	ULT60CL	35	US-LT30B-23	52	UW-131ERK	42
BRH-5U (R,H)	72	UAT60D	33	UDP-A100MC, (TL)	23	ULT70C	35	US-LT30BL-11	52	UW-140P	44
BRH-5UD (R,H)	72	UAT60DL	33	UDP-A120MC, (TL)	23	ULT70CHL	35	US-LT30BL-17	52	UW-140PL	44
BRH-5UG (R,H)	72	UAT60L	33	UDP-A600LMC, (TL)	23	ULT70CCL	35	US-LT30BL-23	52	UW-140PR	44
BRH-5US (R,H)	72	UAT60S	33	UDP-A700MC, (TL)	23	ULT70CCL	35	US-LT31PB-05	53	UW-140PRL	44
BRH-5USD (R,H)	72	UAT60SD	33	UDT-25A/E	79	UMG-450	59	US-LT31PB-11	53	UW-161ER	42
BRH-7 (H)	74	UAT60SDL	33	UDT-200A/E	78	UOW-11-10	38	US-LT31PB-17	53	UW-220P	44
BRH-7 (R)	74	UAT60SL	33	UDT-500A/E	78	UOW-11-14	38	US-LT31PB-23	53	UW-220PL	44
G-38EB	59	UAT70	33	UEC-4801A/E	25	UOW-11-22	38	US-LT40-03C (P)	53	UW-251P	44
PB-20 (R,H)	75	UAT70L	33	UEC-4801A/E (ANGLE)	25	UOW-11-30	38	US-LT40-05C (P)	53	UW-251PL	44
PB-30 (R,H)	75	UAT70S	33	UEC-4801TPA/E	25	UOW-T60-10	38	US-LT40-08C (P)	53	UW-381	44
SBH-0	72	UAT70SL	33	UEC-4801TPA/E (ANGLE)	25	UOW-T60-14	38	US-LT40A-08	52	UW-381L	44
SBH-1A (R,H)	72	UAT80	33	UEC-5500A/E	27	UOW-T60-22	38	US-LT40A-15	52	UW-381P	44
U-310SD	36	UAT80L	33	UECP-4811A/E	22	UOW-T60-30	38	US-LT40A-21	52	UW-381PL	44
U-350D	36	UAT90	33	UECP-4900A	20	UP-15	64	US-LT40AL-08	52	UW-401	43
U-350SD	36	UAT90L	33	UECP-4900E	20	UP-15N	64	US-LT40AL-15	52	UW-401L	43
UA40DMC	31	UAT100	33	UET-10CUA (115V)	80	UP-25DB	64	US-LT40AL-21	52	UW-550	45
UA40MC	31	UAT100L	33	UET-10CUE (230V)	80	UP-25NB	64	US-LT40B-05C	53	UW-B6SLK	42
UA40SDMC	31	UAT130	33	UFC-0N	74	UP-26DB	64	US-LT40B-08	52	UW-O22S	43
UA40SMC	31	UAT130L	33	UFC-1N	74	UP-26NB	64	US-LT40B-08C	53	UW-O32S	43
UA50DMC	31	UAT150	33	UFT-6	81	UP-80-15	64	US-LT40B-15	52	UW-ST6SHK	45
UA50MC	31	UAT150L	33	UFT-10	81	UP-80-40	64	US-LT40B-15C	53	UW-ST6SSHK	45
UA50SDMC	31	UAT180	33	UFT-16	81	UP-80-60	64	US-LT40B-21	52	UW-ST9SK	45
UA50SMC	31	UAT180L	33	UFT-24	81	URD-22RR	70	US-LT40BL-08	52	UW-ST10SHK	45
UA60MC	31	UAT200	33	UG-25NA	59	URW-6	37	US-LT40BL-15	52	UXR-1820MC	31
UA60SDMC	31	UAT200L	33	UG-25NSA	59	URW-8	37	US-LT40BL-21	52	UXR-2000	36
UA60SMC	31	UBX-AF500Z	12	UG-38N	59	URW-8N	37	US-LT41PB-08	53	UXR-2000MC	31
UA70MC	31	UBX-AF600Z	12	UG-38NA	59	URW-9N	37	US-LT41PB-15	53	UXR-2000S	36
UA70SMC	31	UBX-AF700Z	12	UG-38NL	59	URW-10N	37	US-LT41PB-21	53	UXR-2400S	36
UA80MC	31	UBX-AF900Z	12	UG-38NS	59	URW-12N	37	US-LT50B-05	52	UXR-2400SMC	31
UA90MC	31	UBX-T40D	13	UG-38NSA	59	URW-12NA	37	US-LT50B-08	52	UXR-3000S	36
UA100MC	31	UBX-T40D (RF8)	14	UG-38NSL	59	URW-12NB	37	US-LT50B-17	52	UXR-2400S	33
UA130MC	31	UBX-T40D (Z)	14	UG-45H	59	URW-60	37	US-LT51PB-05	53	UXR-T3000S	33
UA150MC	31	UBX-T50	13	UG-50S-200	59	URW-60R	37	US-LT51PB-08	53		
UA400AMC	29	UBX-T50 (RF8)	14	UG-50S-200A	59	URW-80	37	US-LT51PB-17	53		
UA500AMC	29	UBX-T50 (Z)	14	UG-65E	60	URW-80R	37	US-LT60P-03	53		
UA600AMC	29	UBX-T50D	13	UG-65EB	60	URW-81	37	US-LT60P-07	53		
UA700AMC	29	UBX-T50D (RF8)	14	UG-65EBL	60	URW-81R	37	US-LT60P-11	53		
UA800AMC	29	UBX-T50D (Z)	14	UG-65EBR	60	US-3.5A	54	USG-4S	61		
UA900AMC	29	UBX-T60	13	UG-65EL	60	US-3.5ACB	54	USG-4VL	61		
UA1000AMC	29	UBX-T60 (RF8)	14	UG-65ER	60	US-3.5B	54	USG-5VLA	61		
UA1300AMC	29	UBX-T60 (Z)	14	UG-65E	60	US-3.5MA	54	USG-7S	60		
UAG-40SB-136	62	UBX-T60D	13	UG-650EL	60	US-3.5PB	54	USG-45P	64		

URYU NETWORK

URYU have gained market share with the highest satisfaction of our customers not only island but also far abroad in more than 40 countries through a world-wide network of independent distributors who offer tool inspection, repair, testing, maintenance and quick delivery.

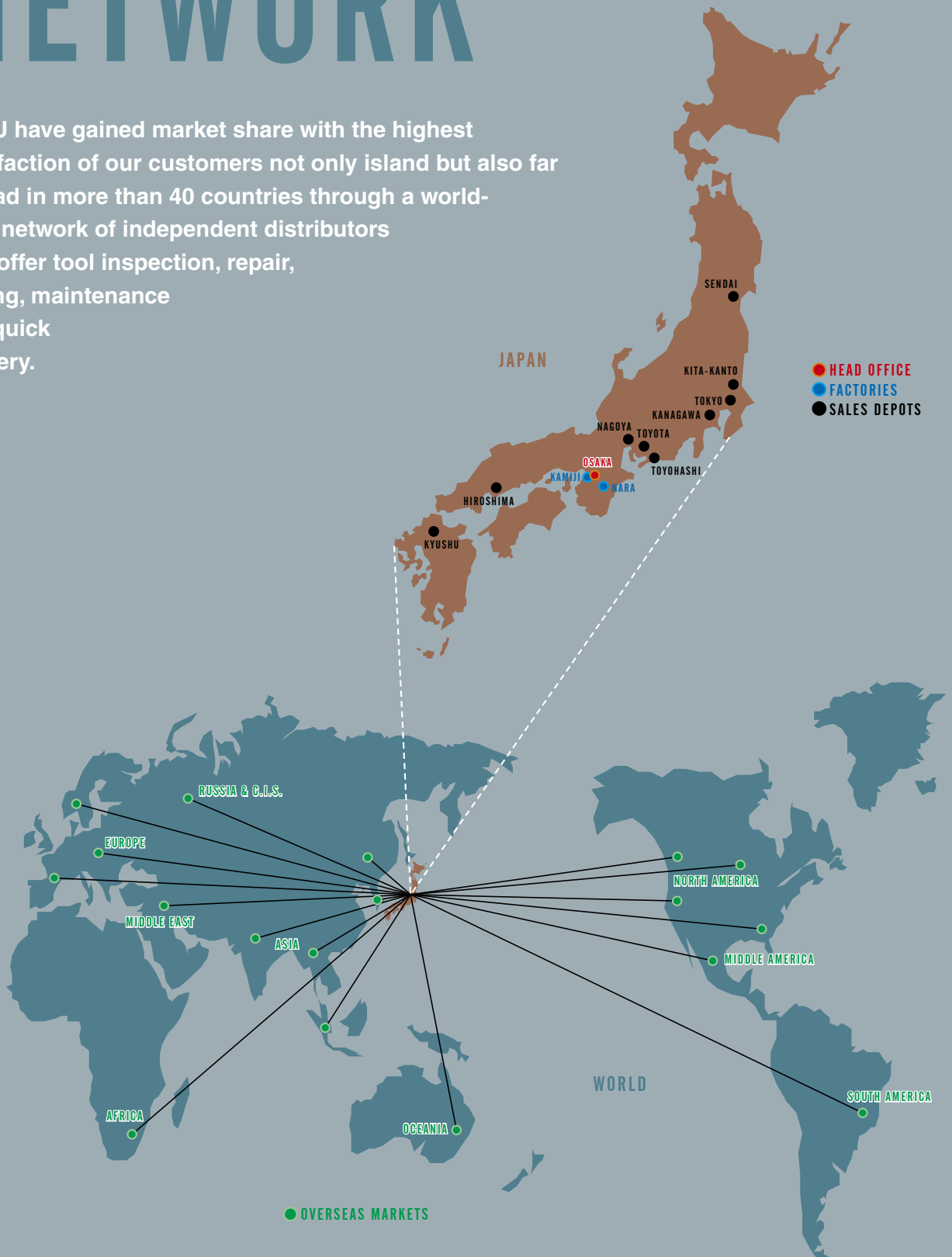

POWER TOOLS GENERAL CATALOG

BOLT & NUT SETTERS / SCREWDRIVERS / ABRASIVE TOOLS /
DRILLS & TAPPERS / PERCUSSION TOOLS / TESTERS & ACCESSORIES

www.uryu.co.jp

Specifications & contents are subject to change without notice.

 **URYU SEISAKU, LTD.**

P.O. Box 7 Higashinari, Osaka, Japan.
Telephone No : 816-6973-9414~9415
Fax : 816-6972-0346
E-Mail : uryuair@uryu.co.jp
<https://www.uryu.co.jp>



23-09



DISTRIBUTED BY :

Printed in Japan
(DAI-23-09-1523)